

# 18515 MECHA STRIKE ALTERNATE BUILD

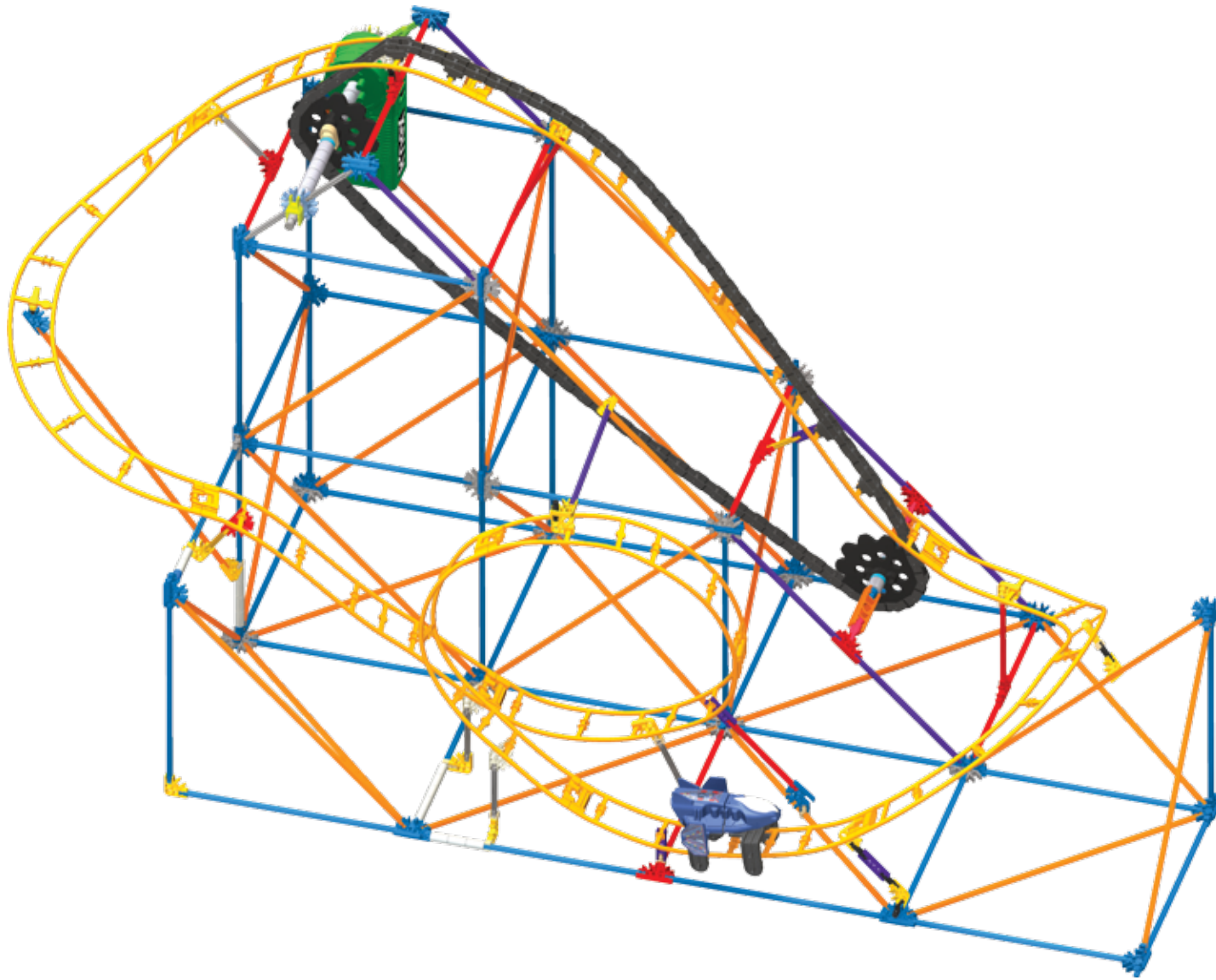

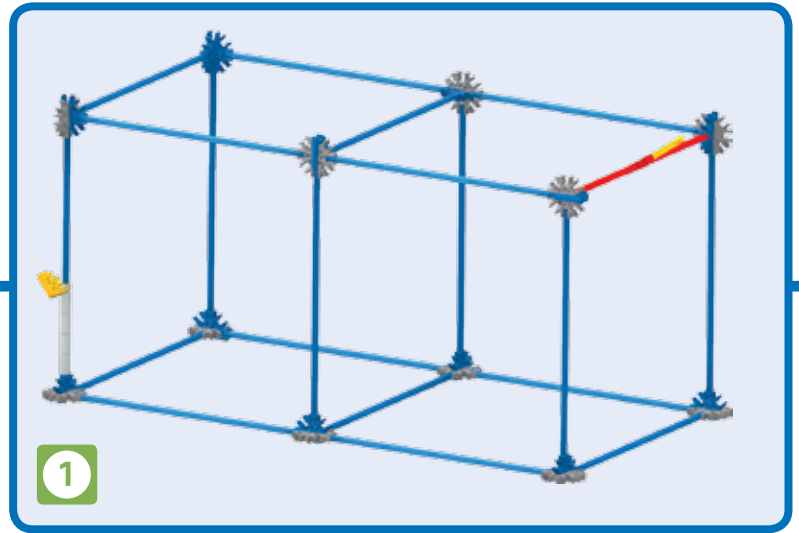





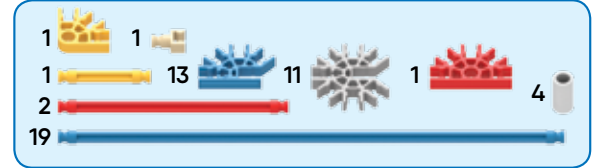
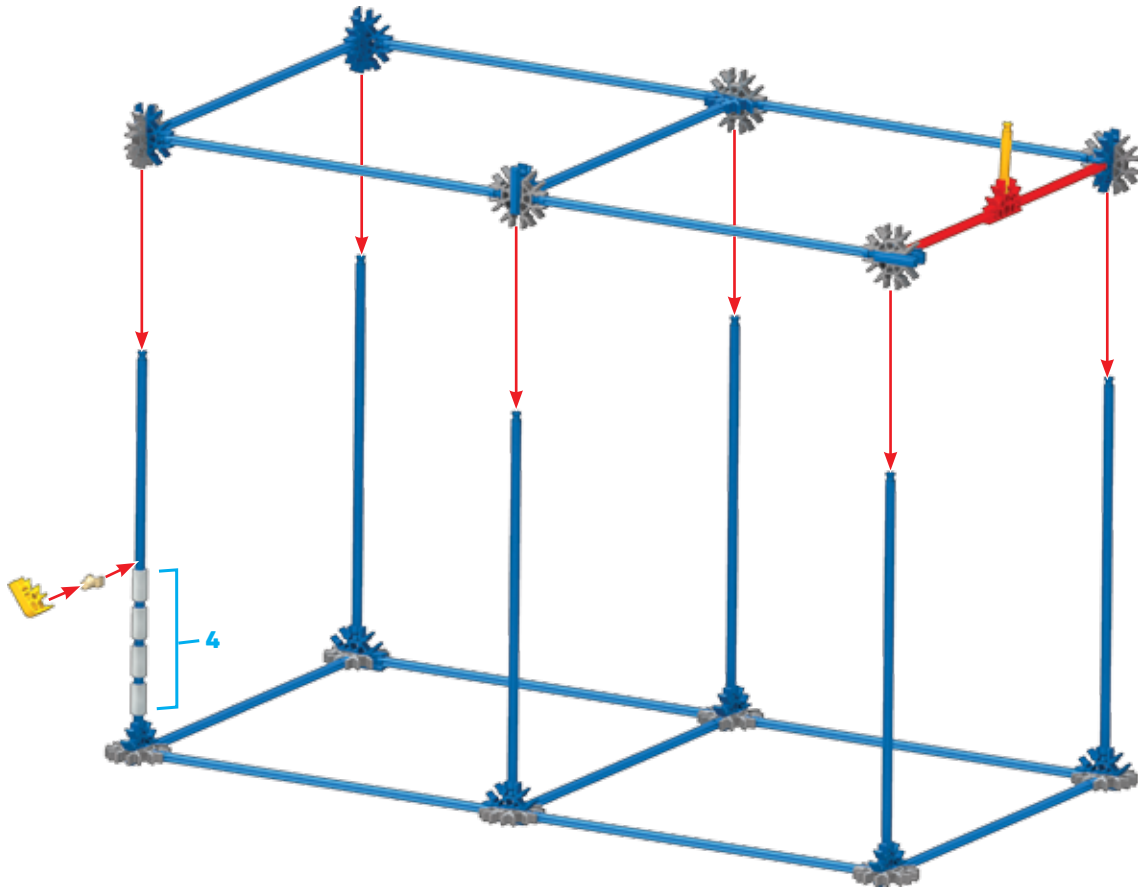



**TIP:** While you're building make sure you face your model in the same direction as the pictures shown in the instructions.

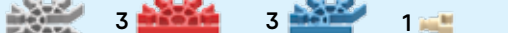

1



- 1  2  2 
- 3  2  2 
- 4 
- 2 
- 1  3  3  1 

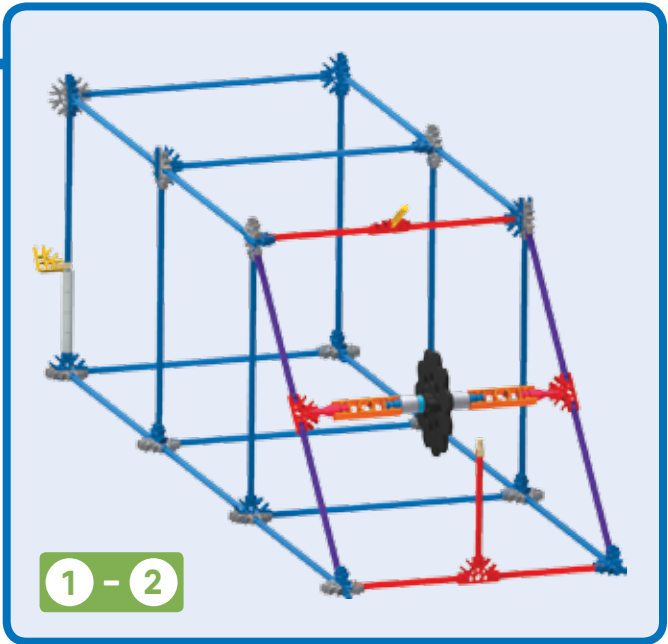

2

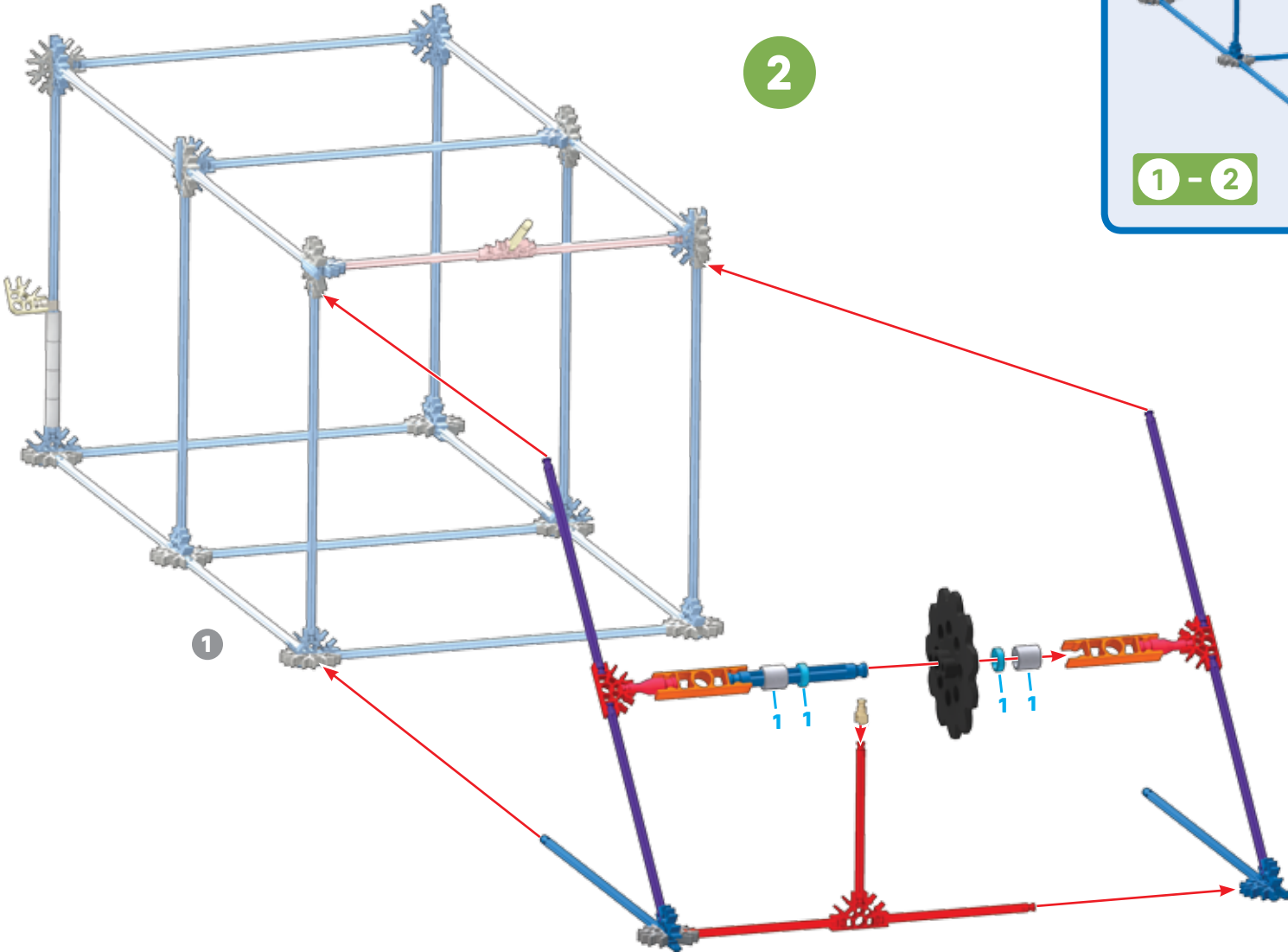

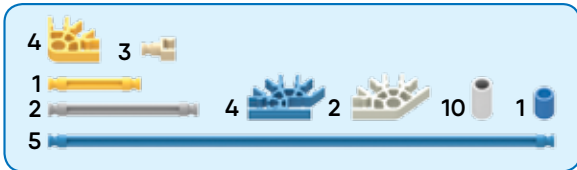

3

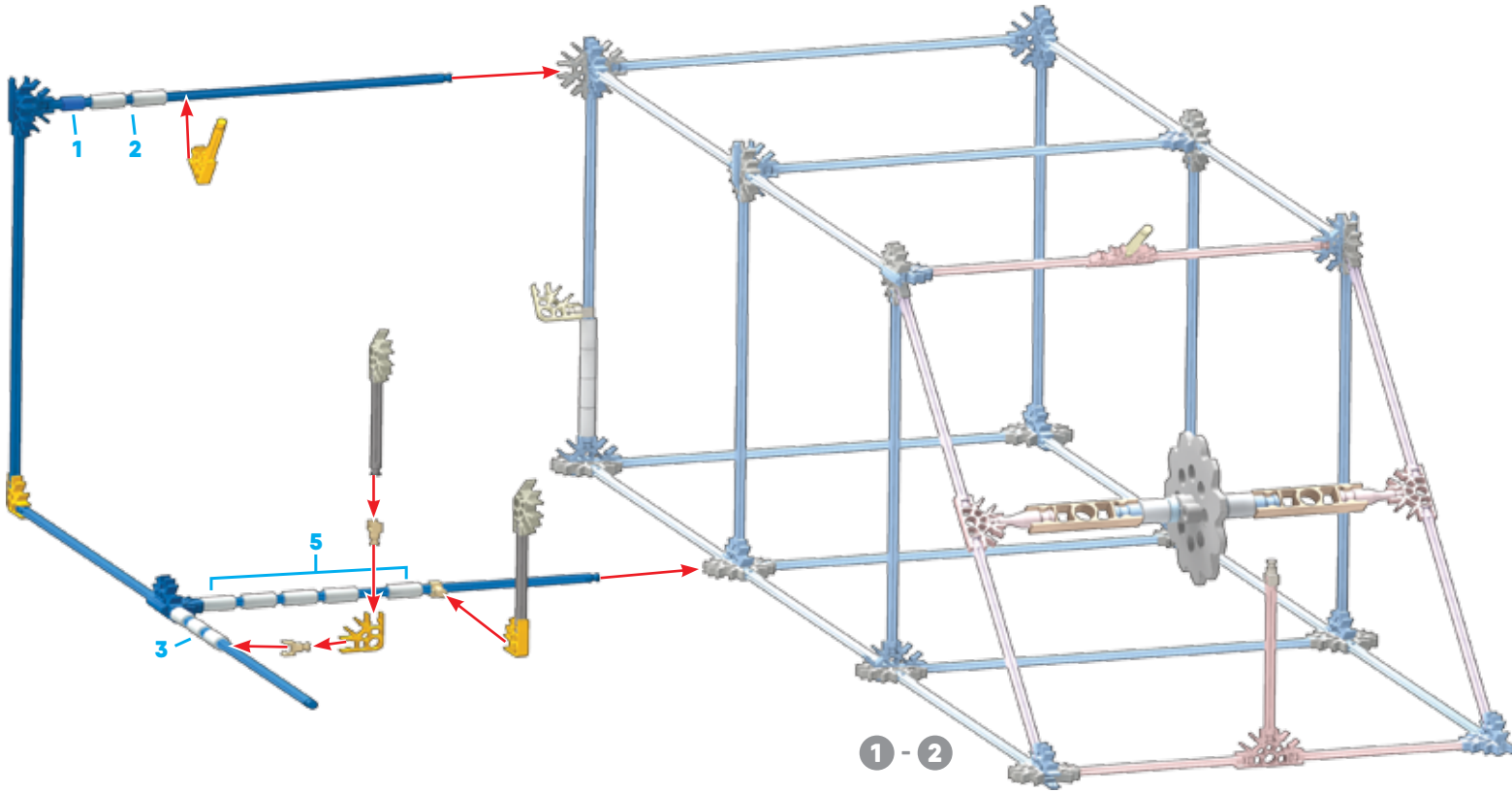
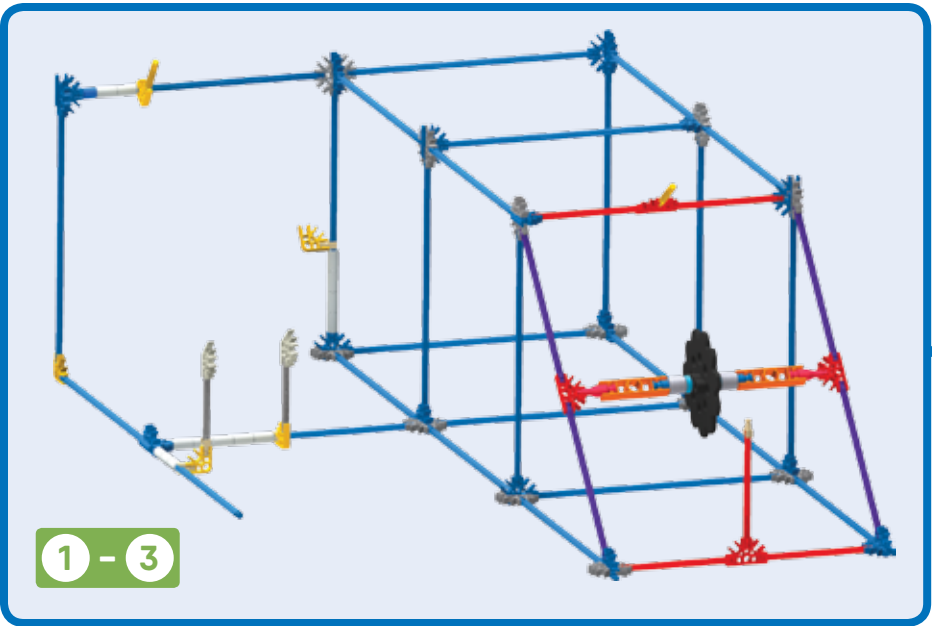



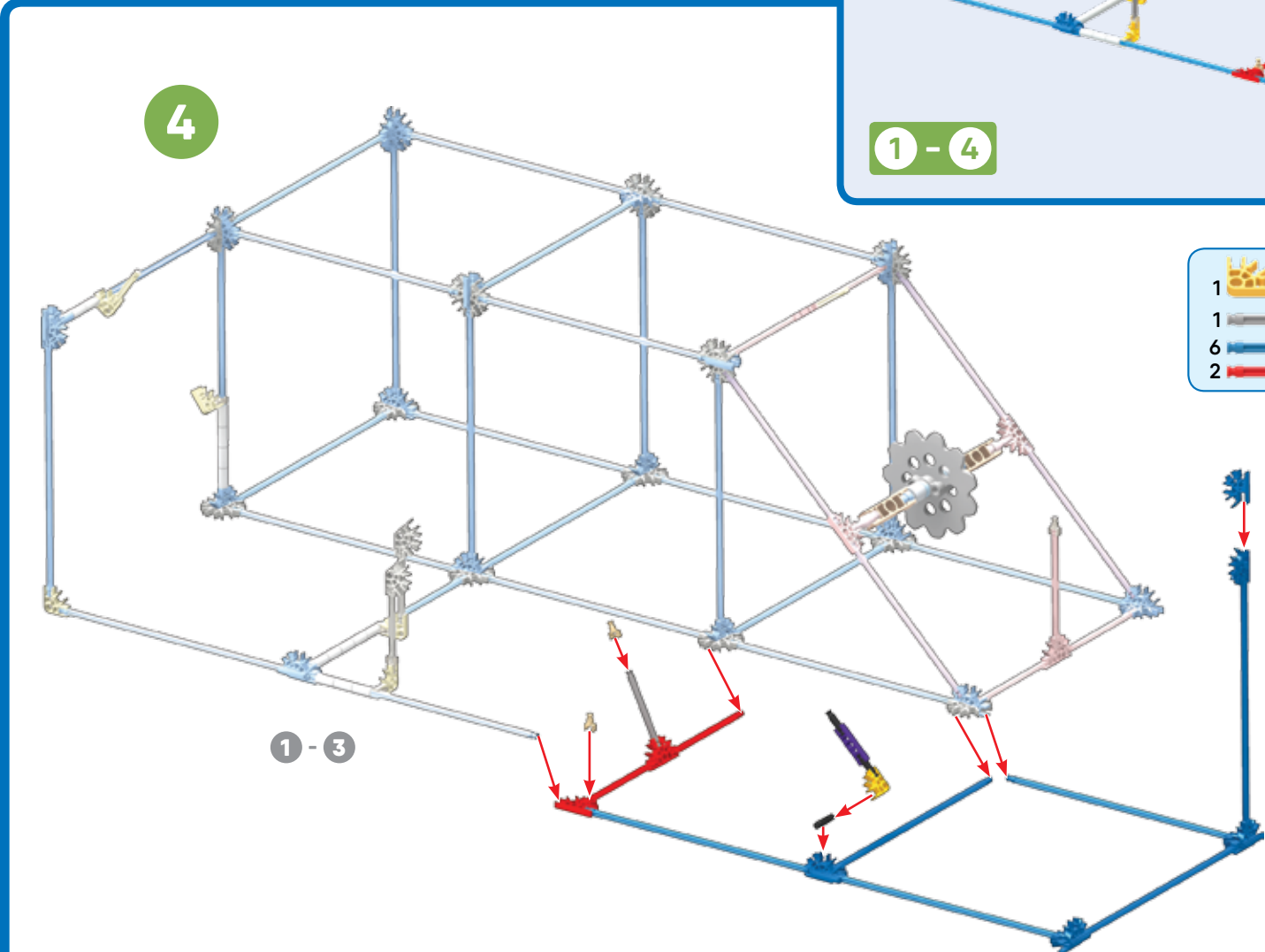
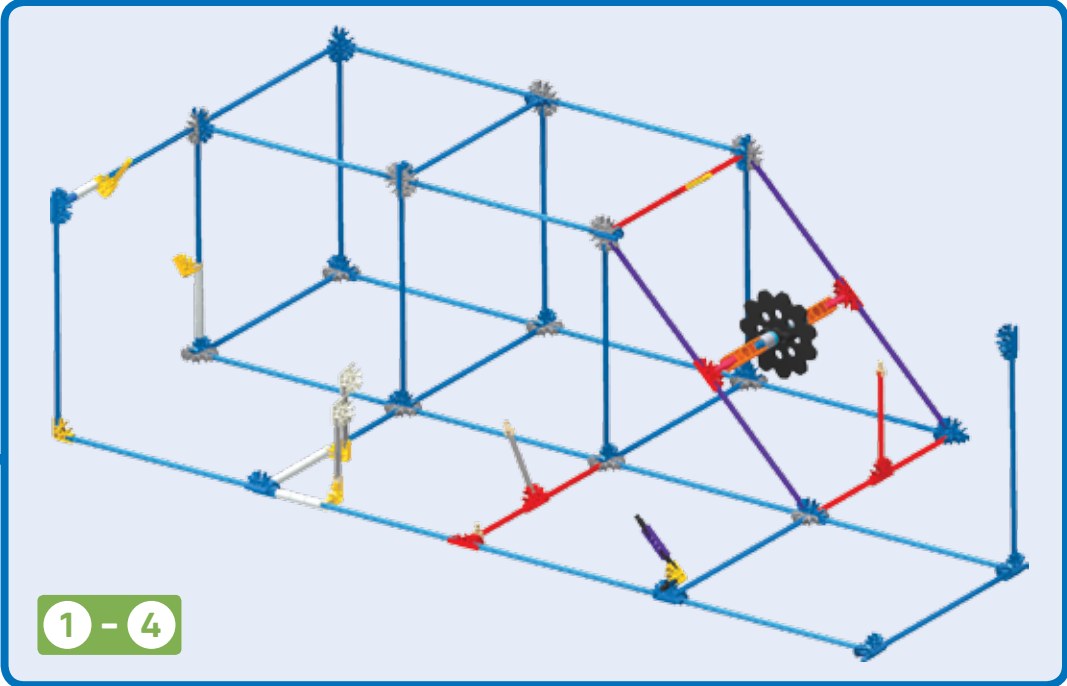

1		2		3	
1		1		8	
6				2	
2					

- 1  1  1 
- 8 

5

1 - 5

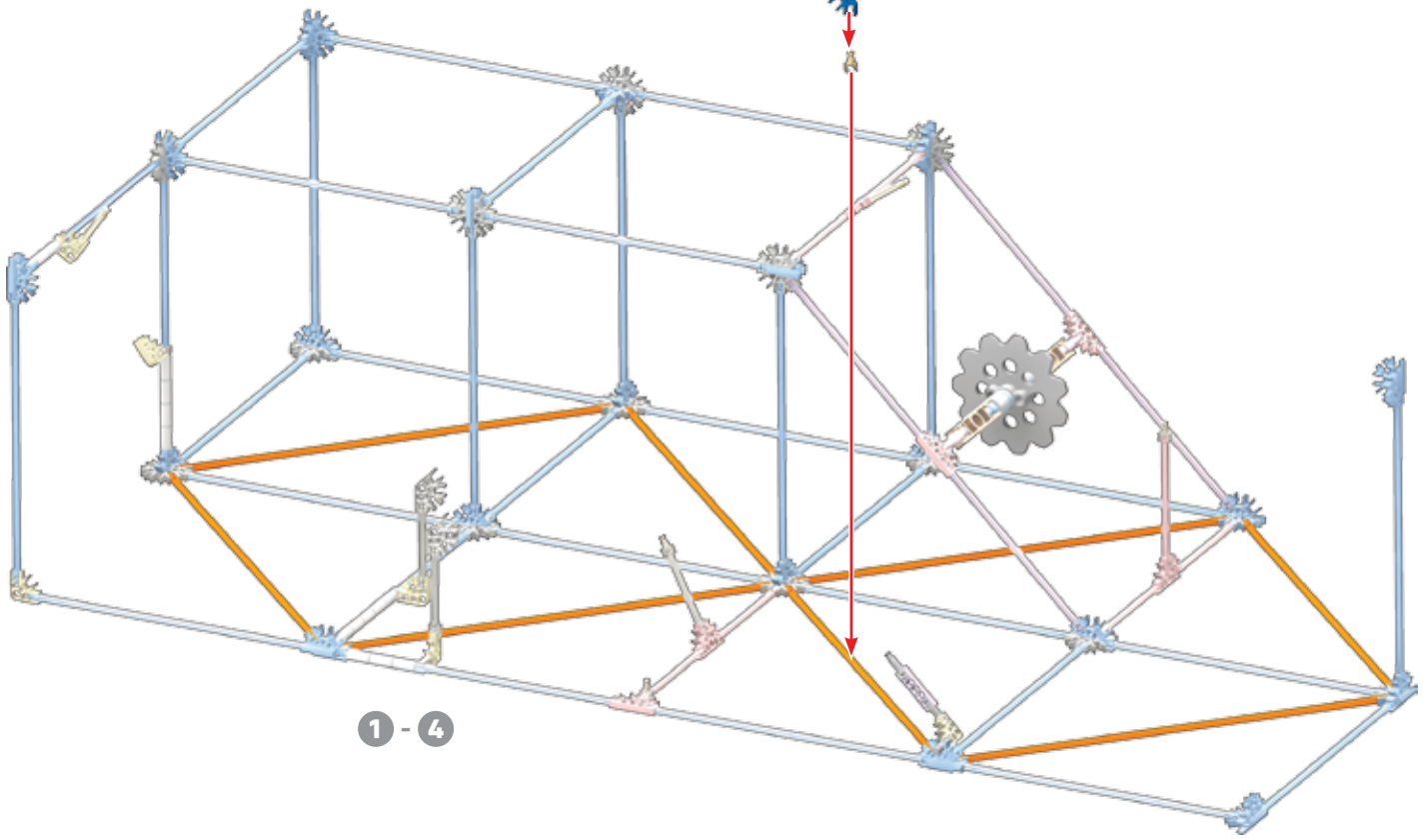
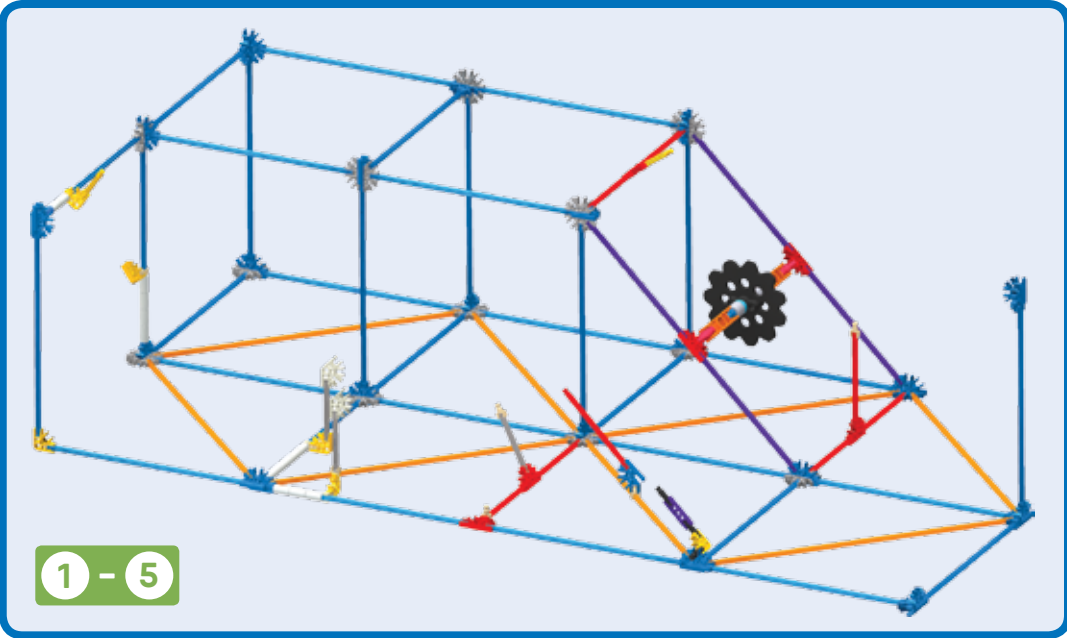

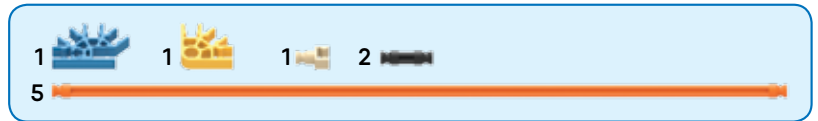
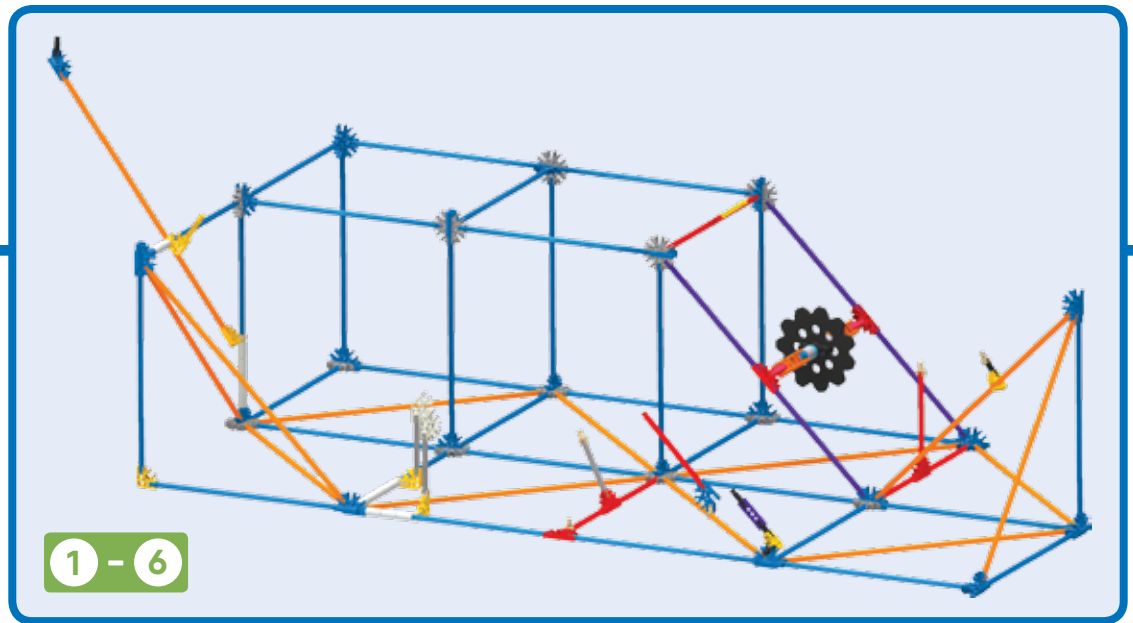

6

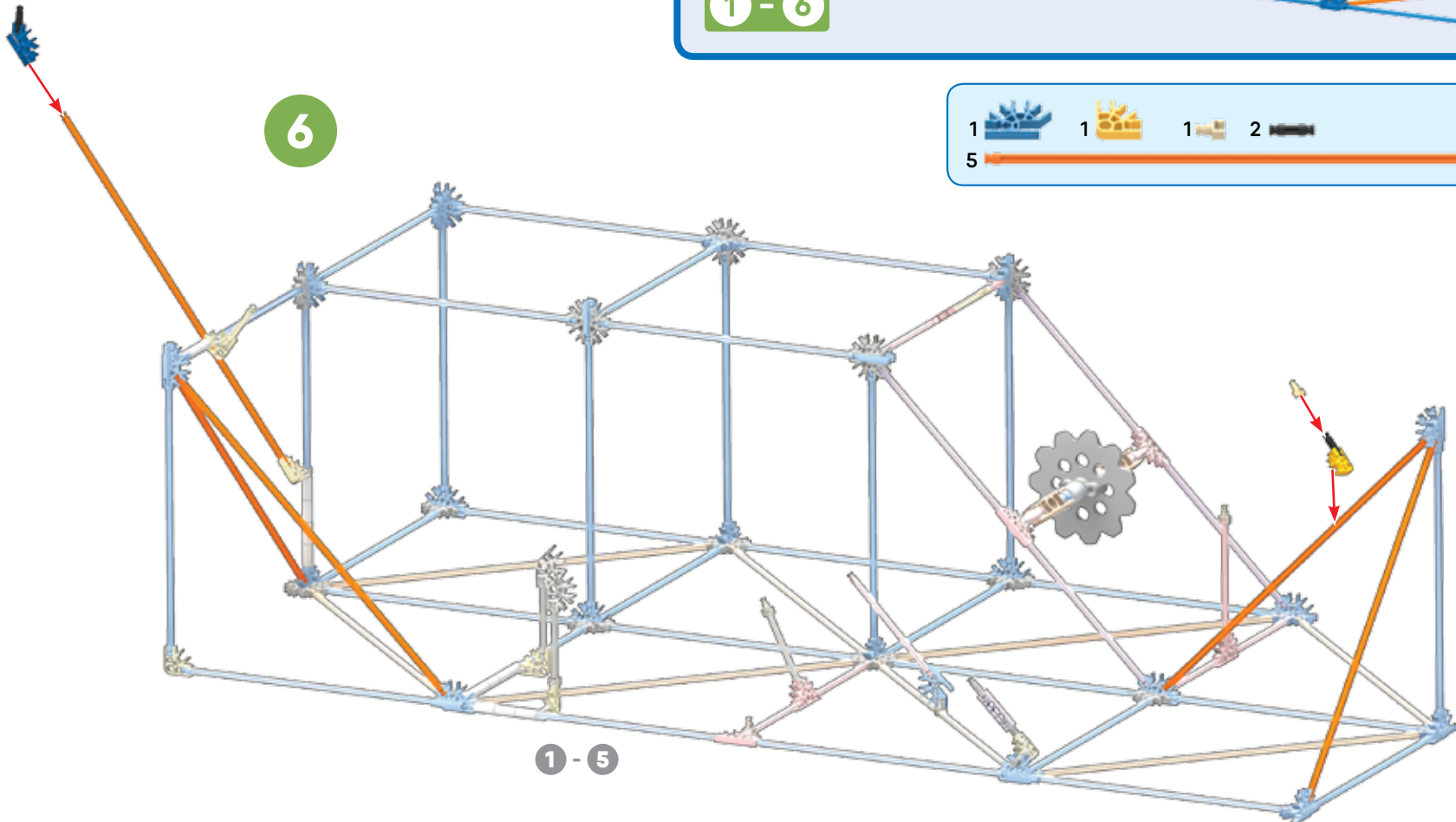

7

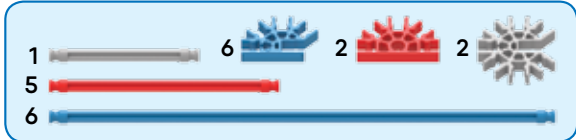
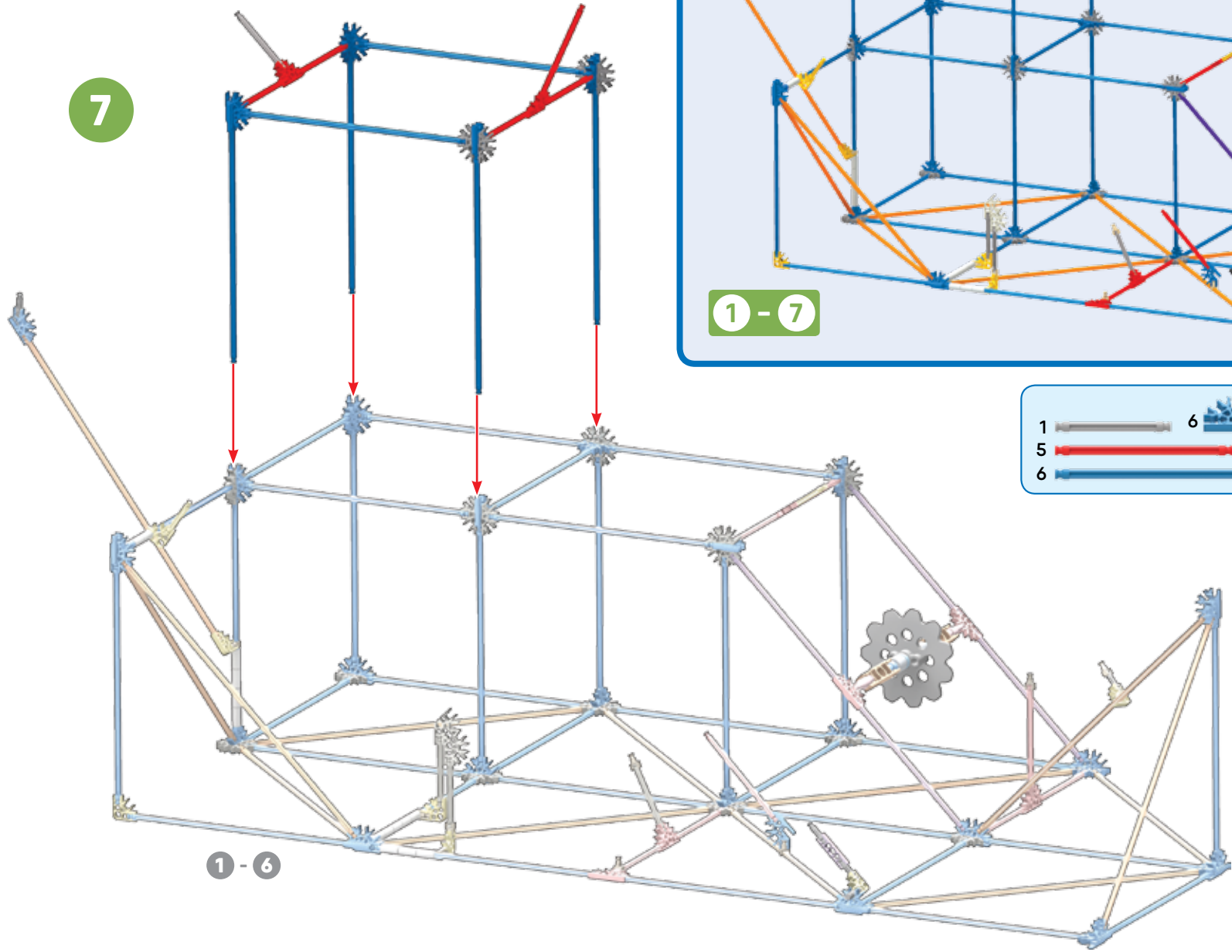
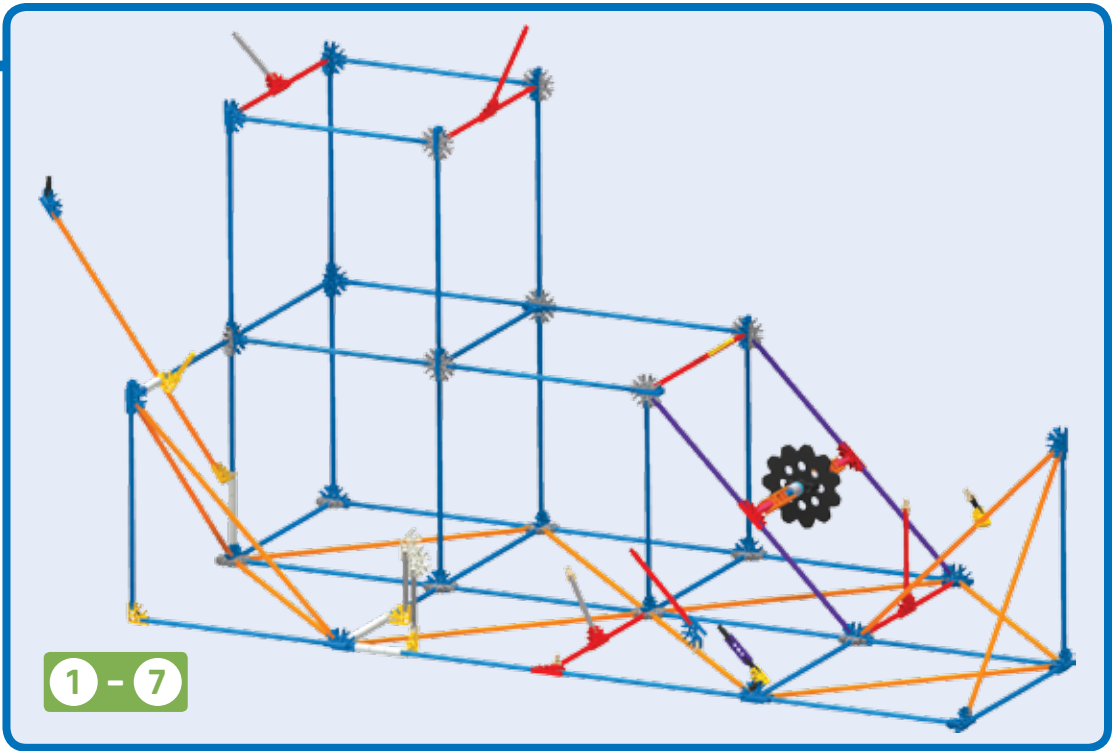

5

8

1 - 7

1 - 8

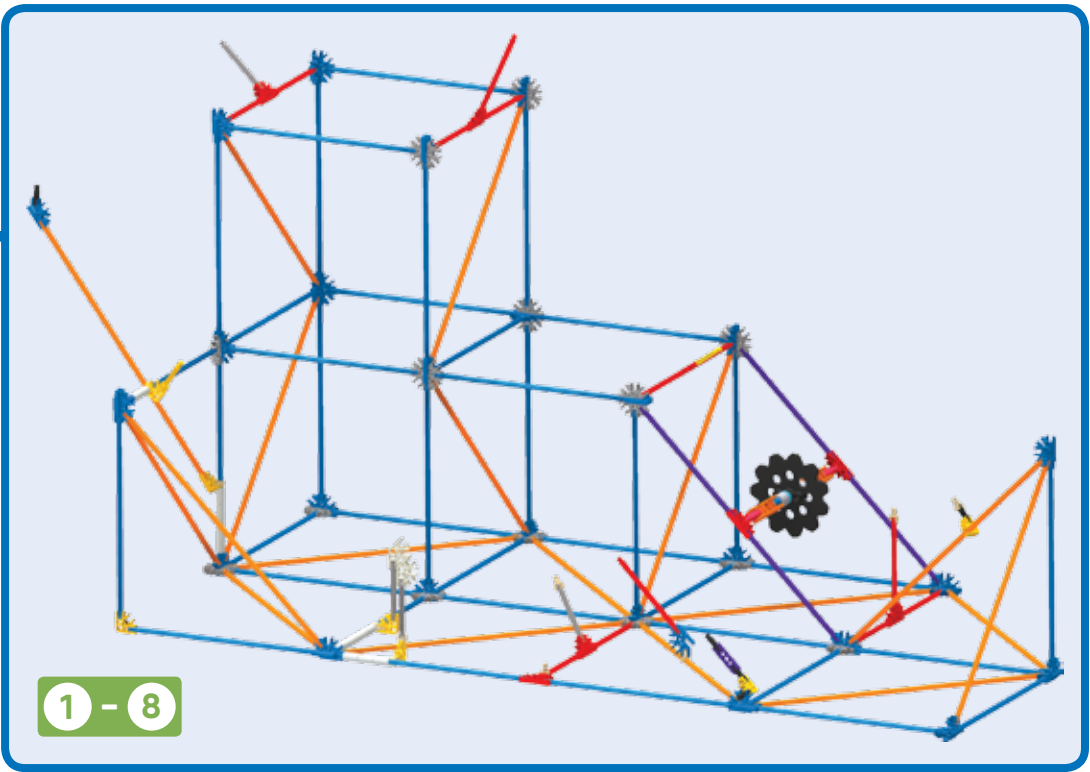
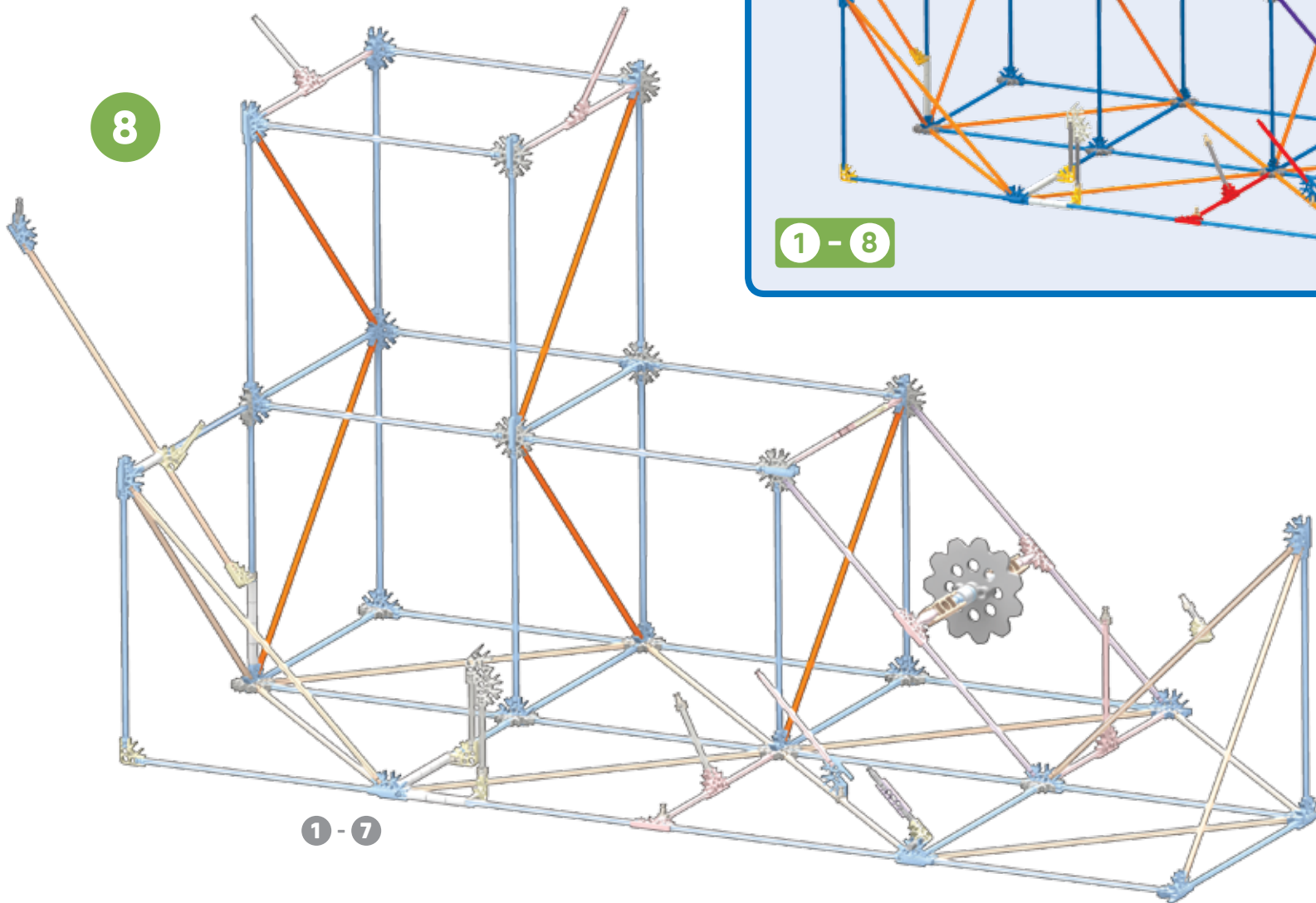



9

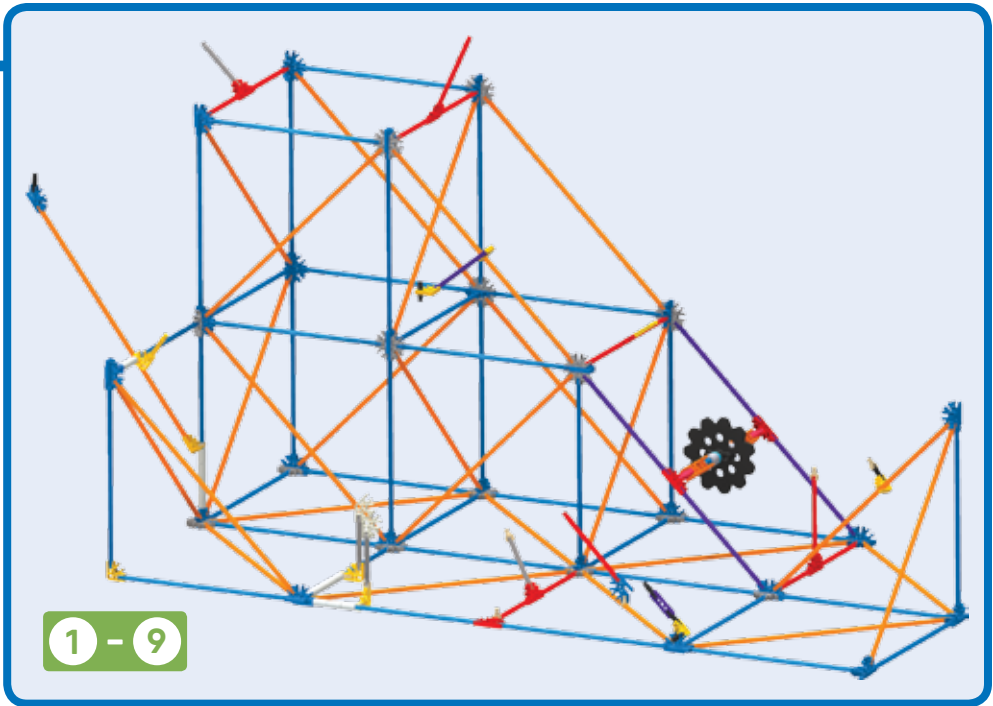
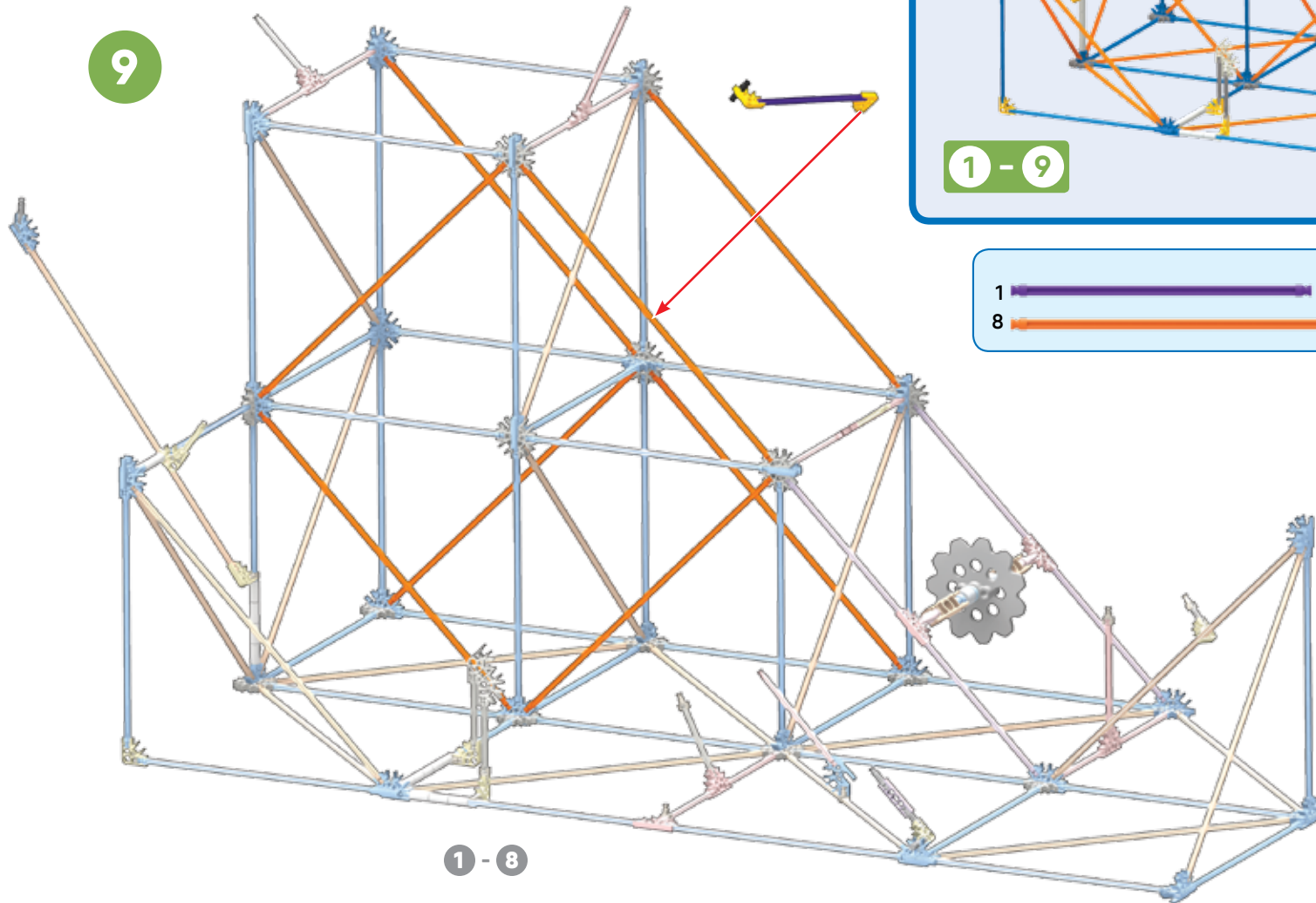



Did you install 2 AA (or LR6) batteries in the motor?

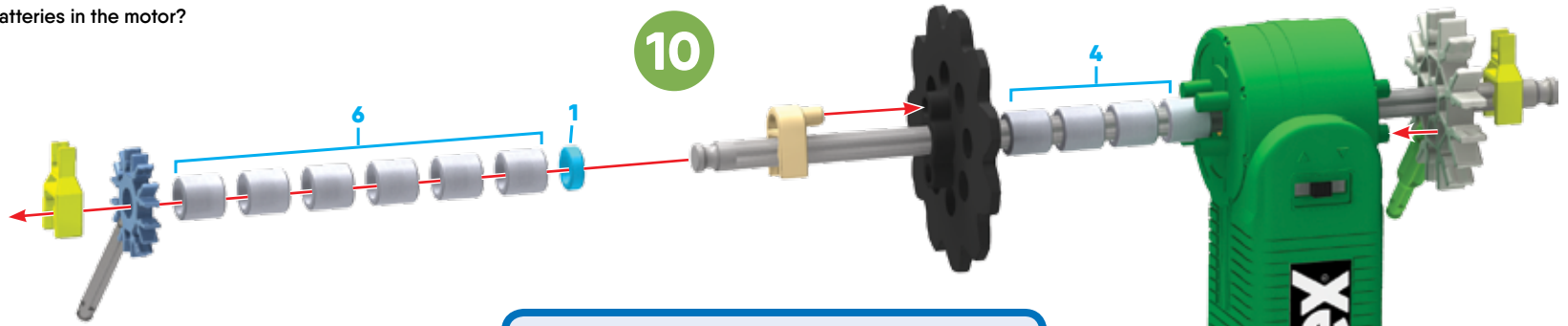

10

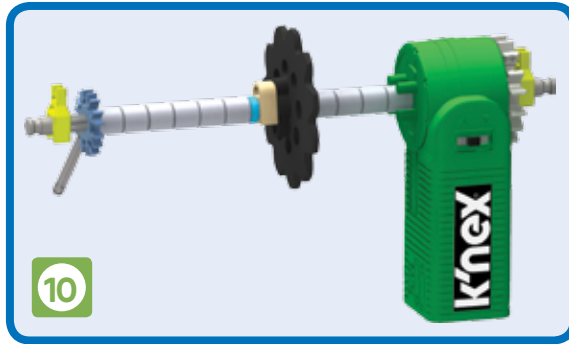

10

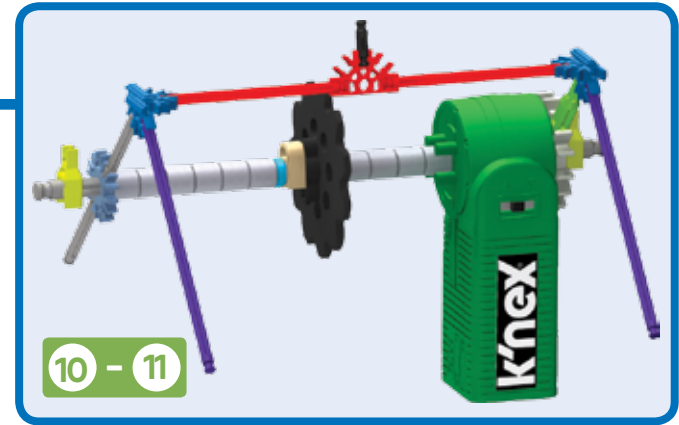
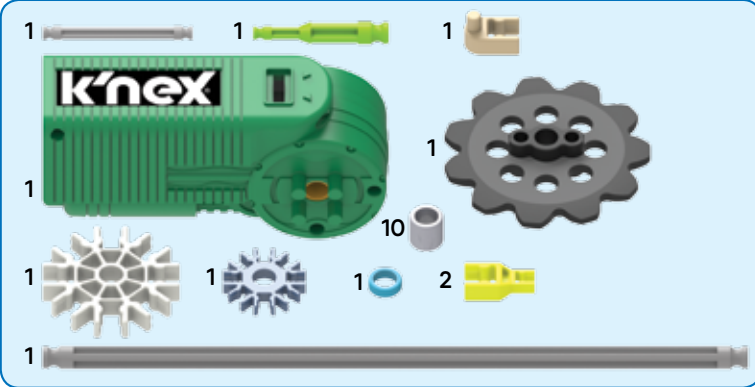

10 - 11

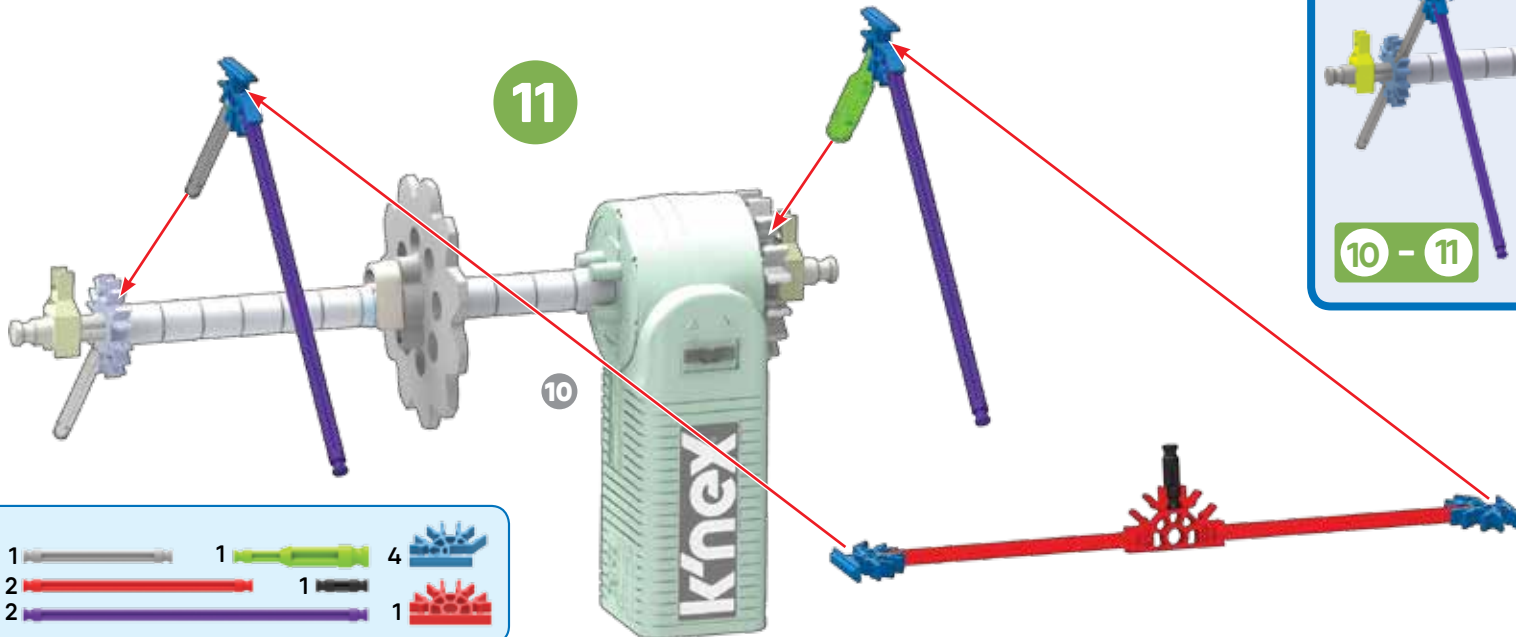

11

10

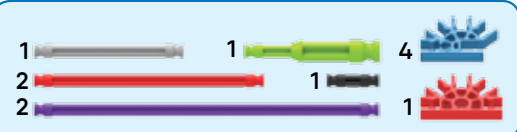

12

10 - 11

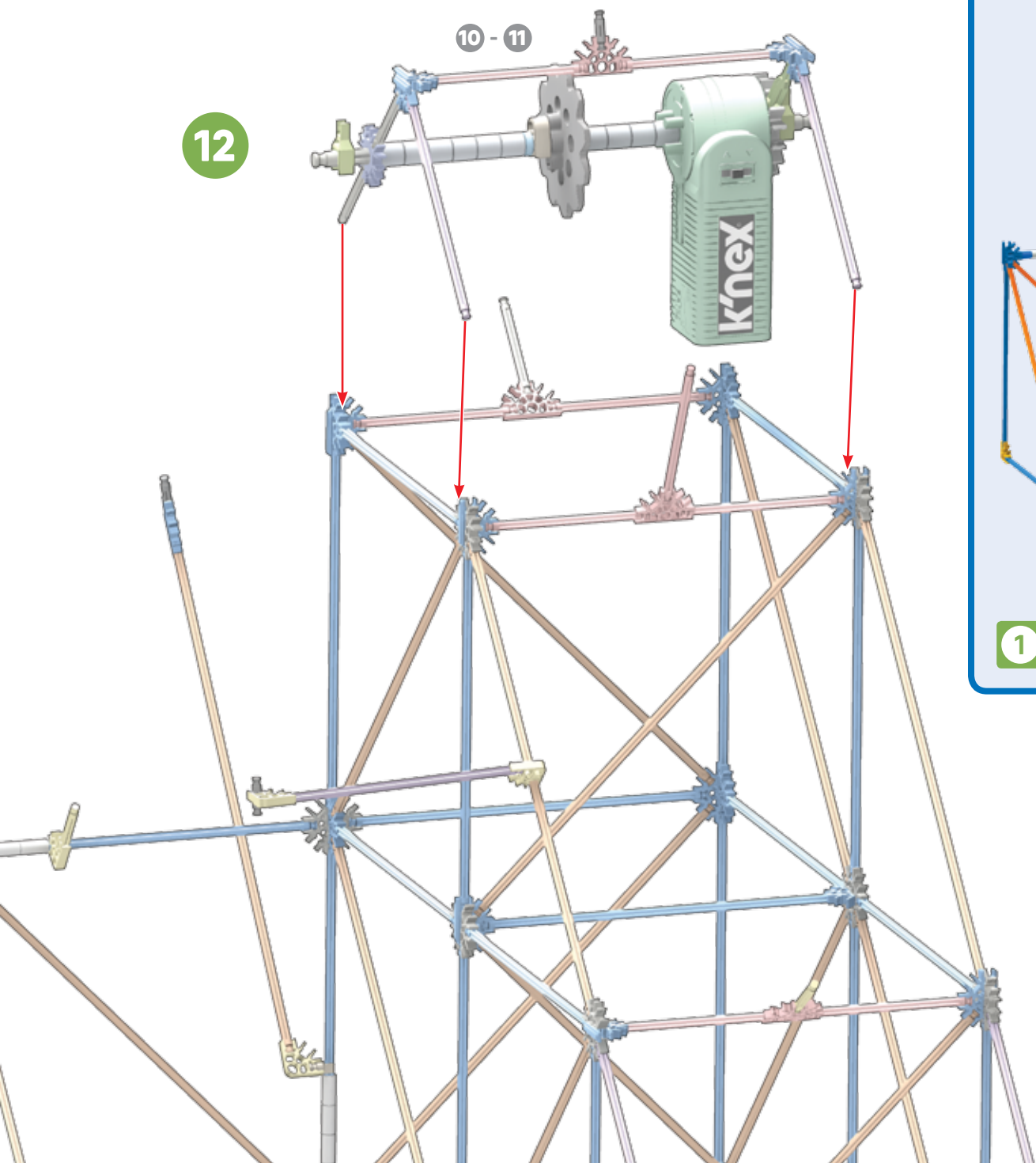

1 - 12

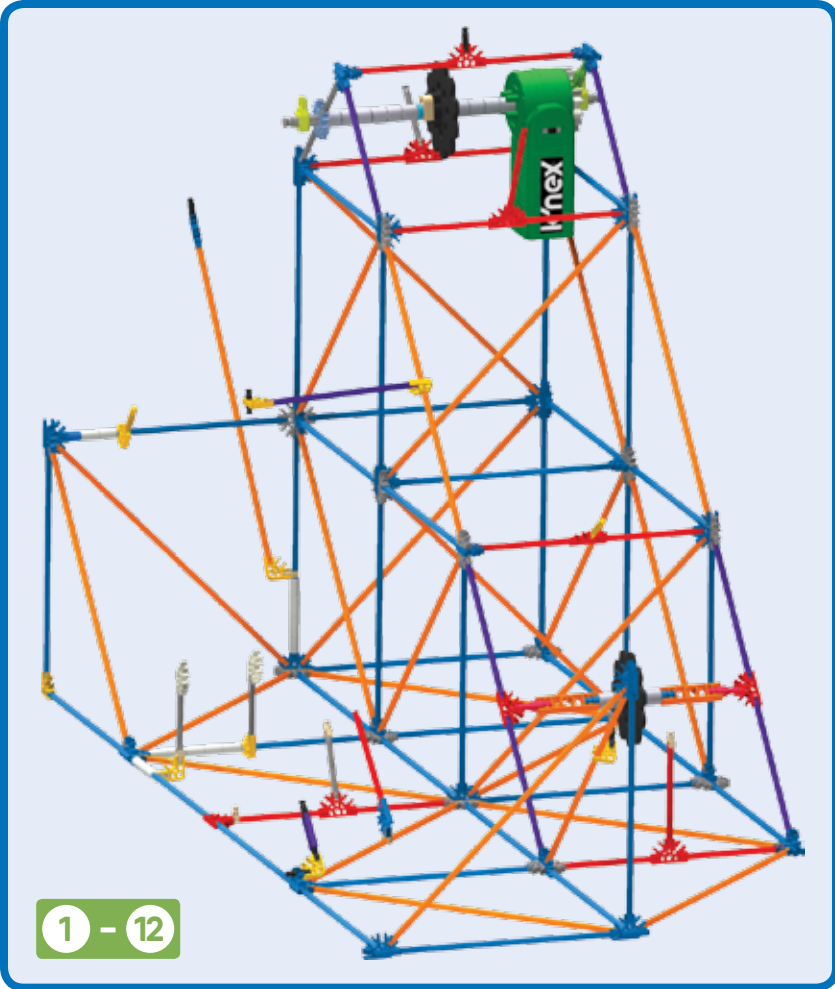

1 - 9

Attach the black chain guides to the top of the track and attach the connectors to the bottom of the track exactly as shown. Be sure to push the connectors on firmly until they "click".

13

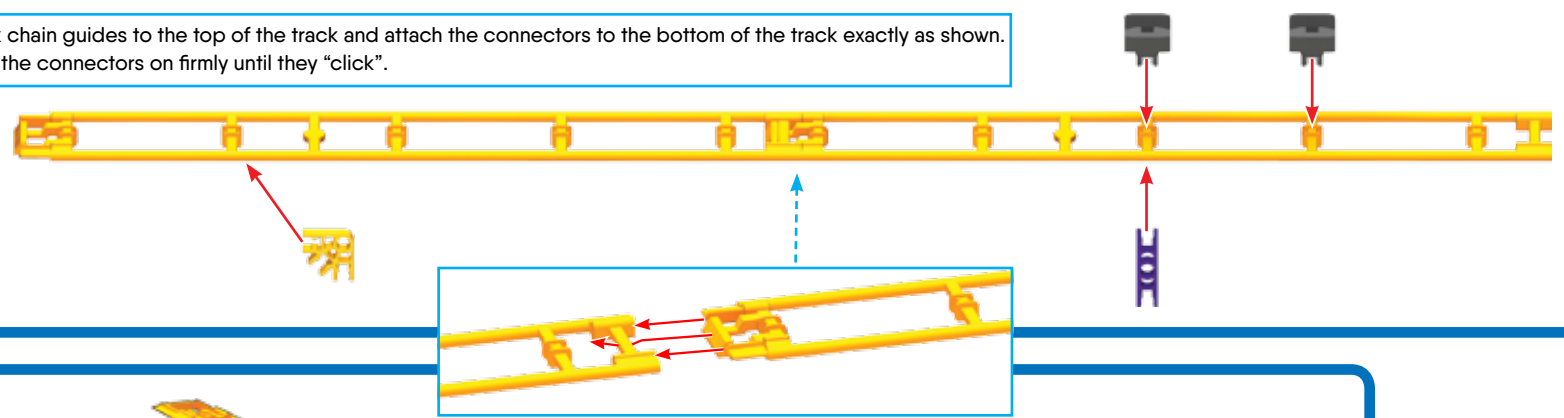

14

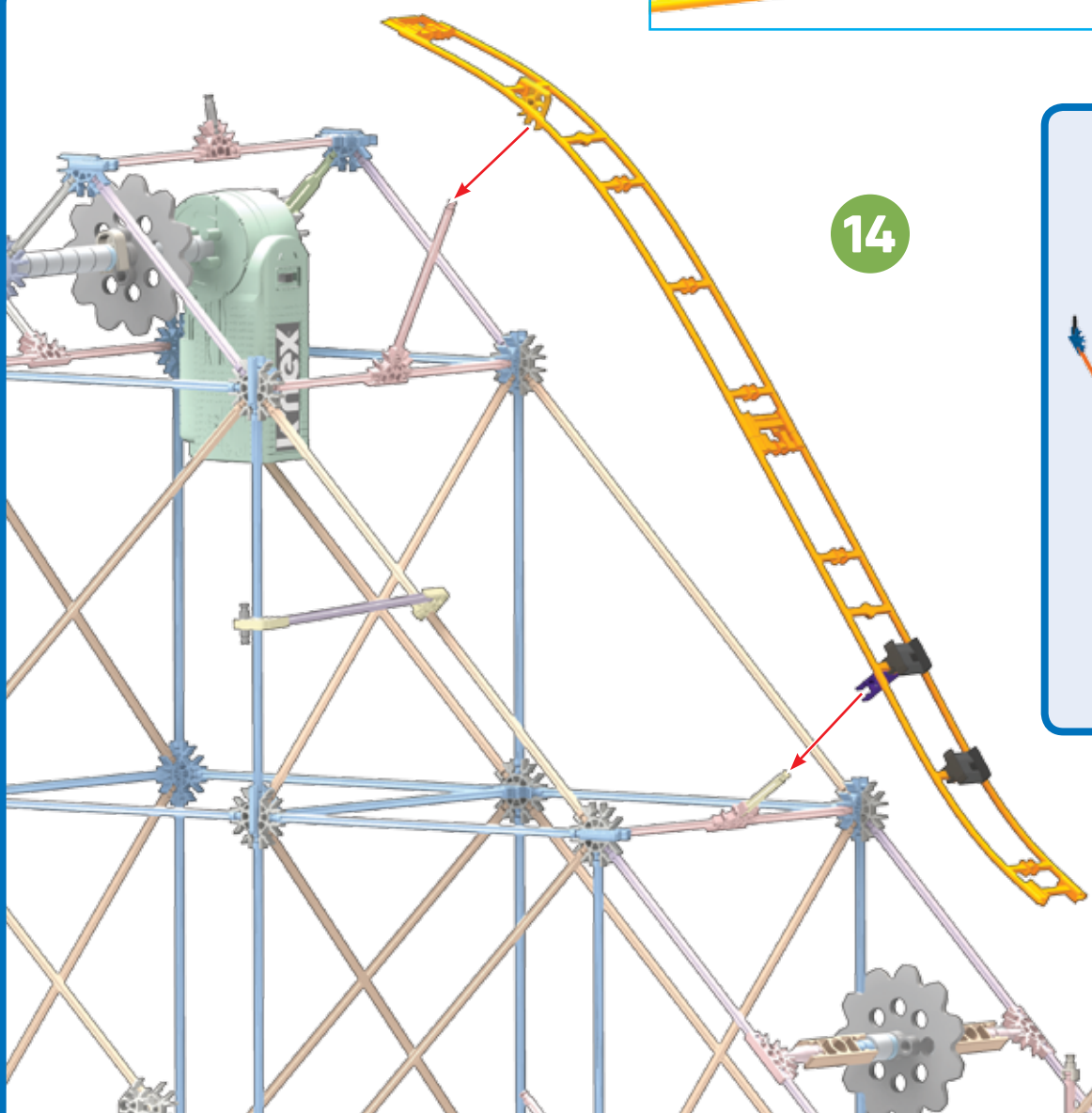

1 - 14

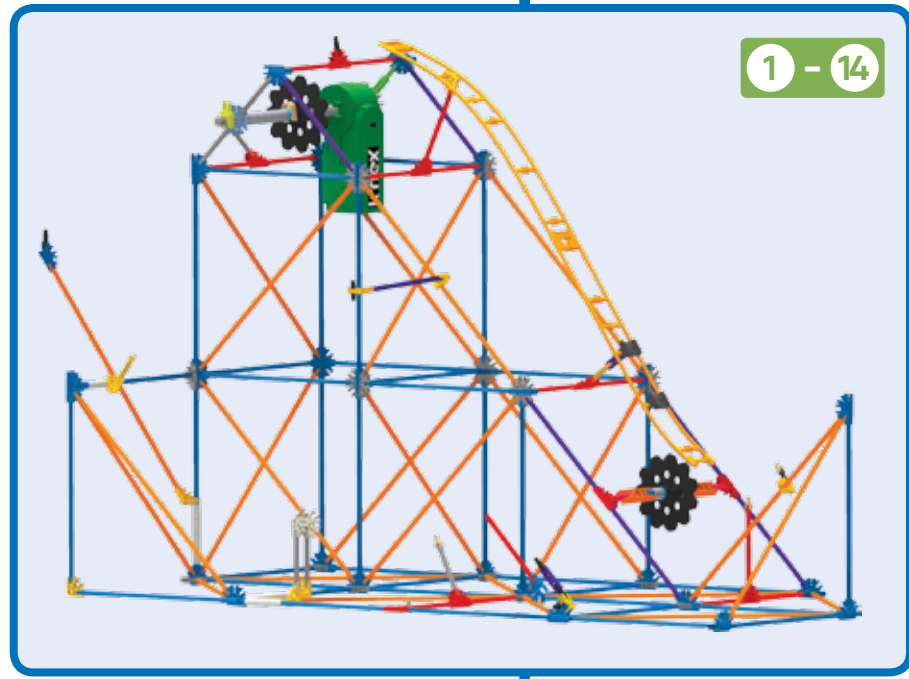

15

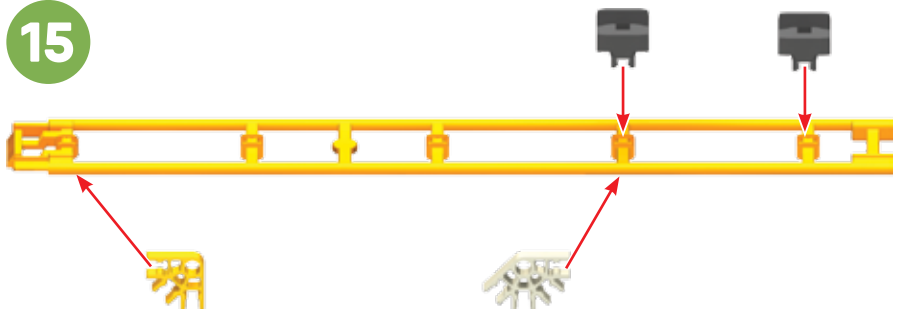

1 - 16

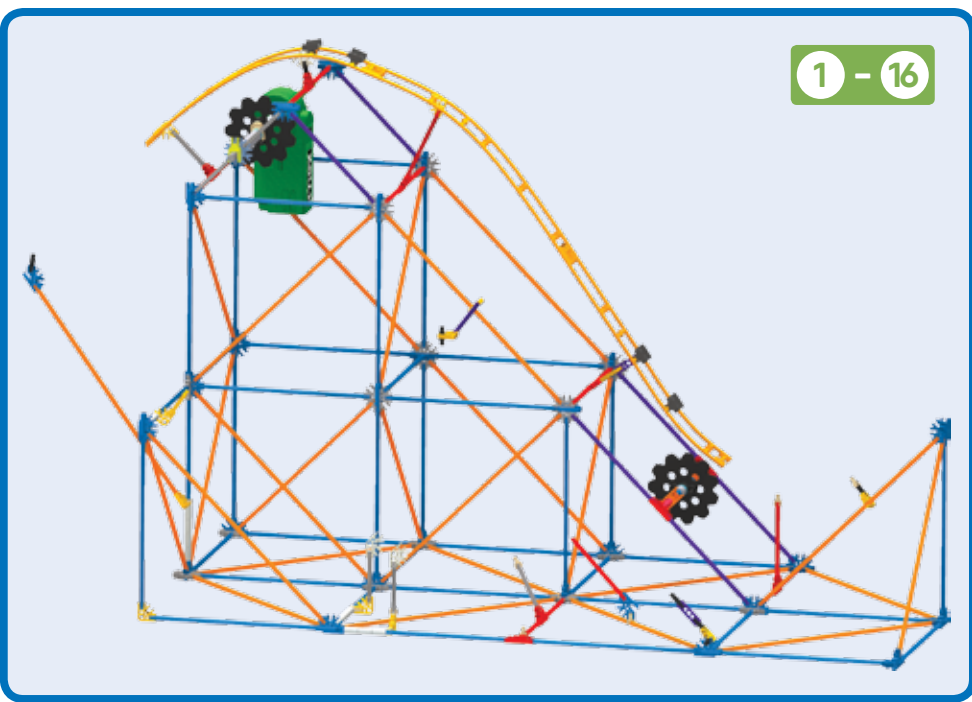

16

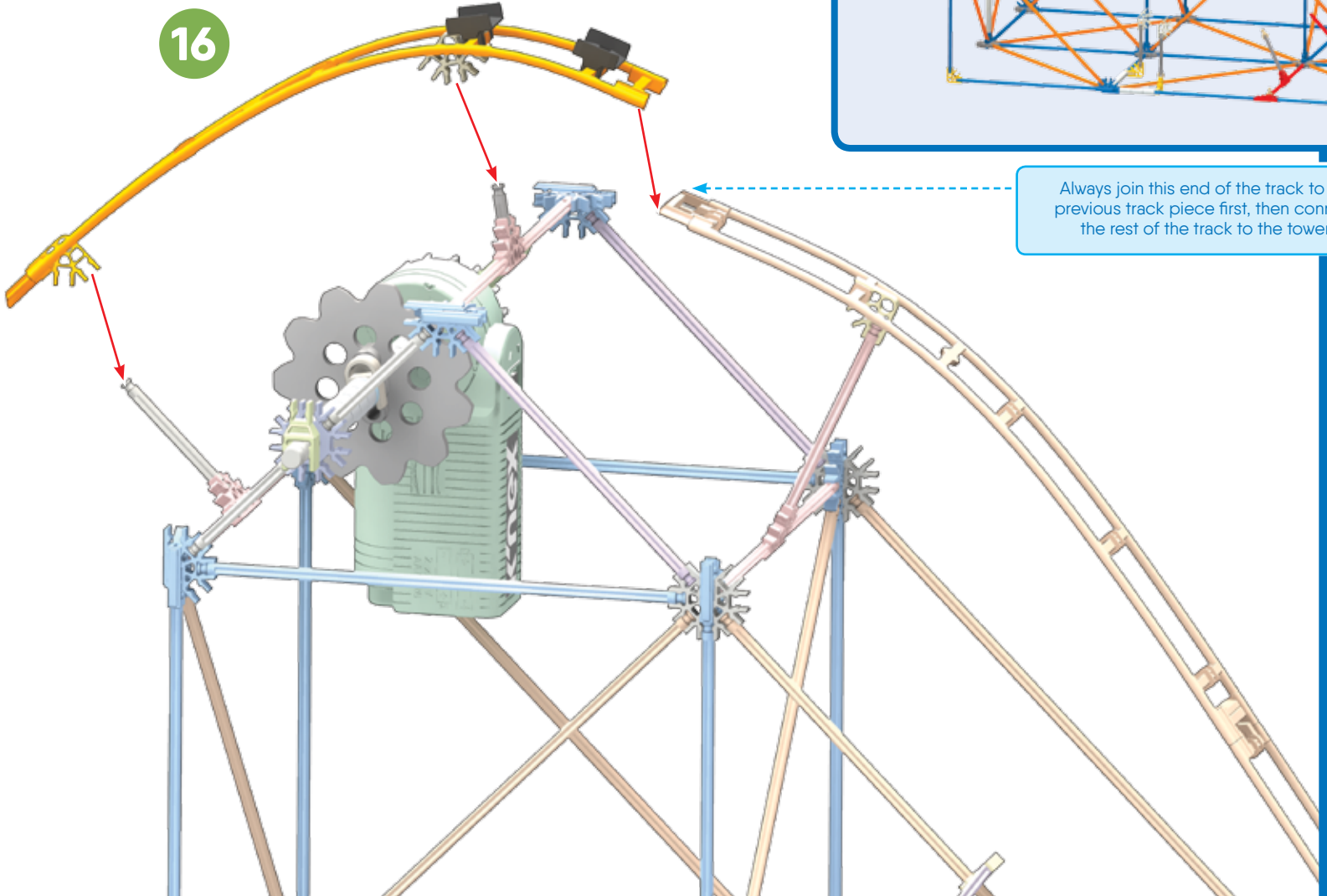

Always join this end of the track to the previous track piece first, then connect the rest of the track to the tower.



17

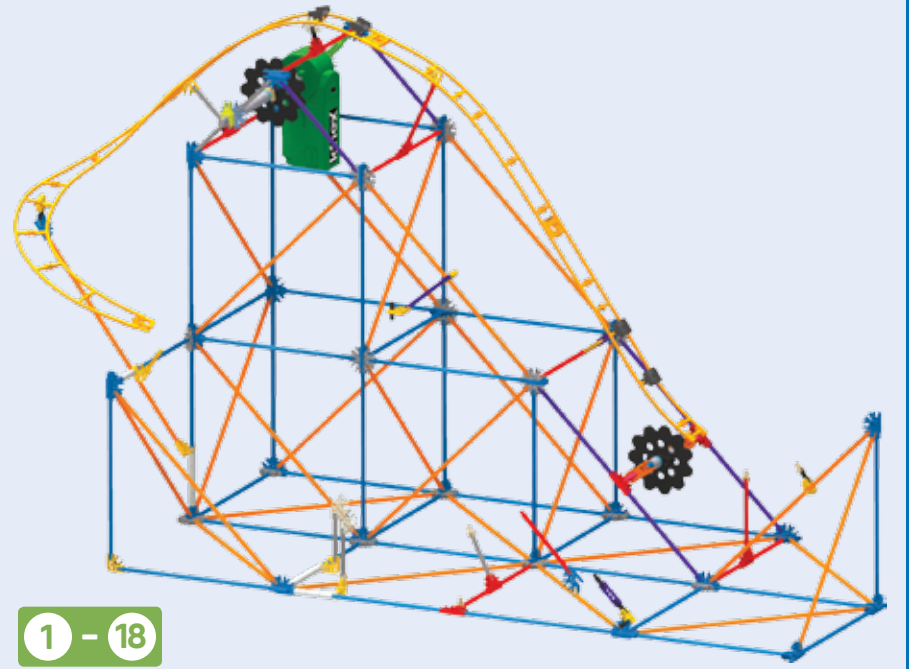
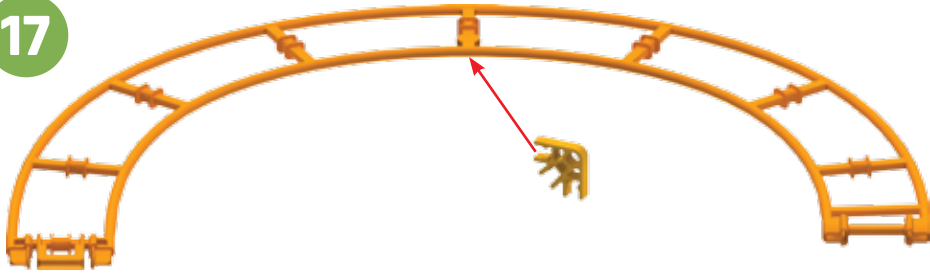

1 - 18

18

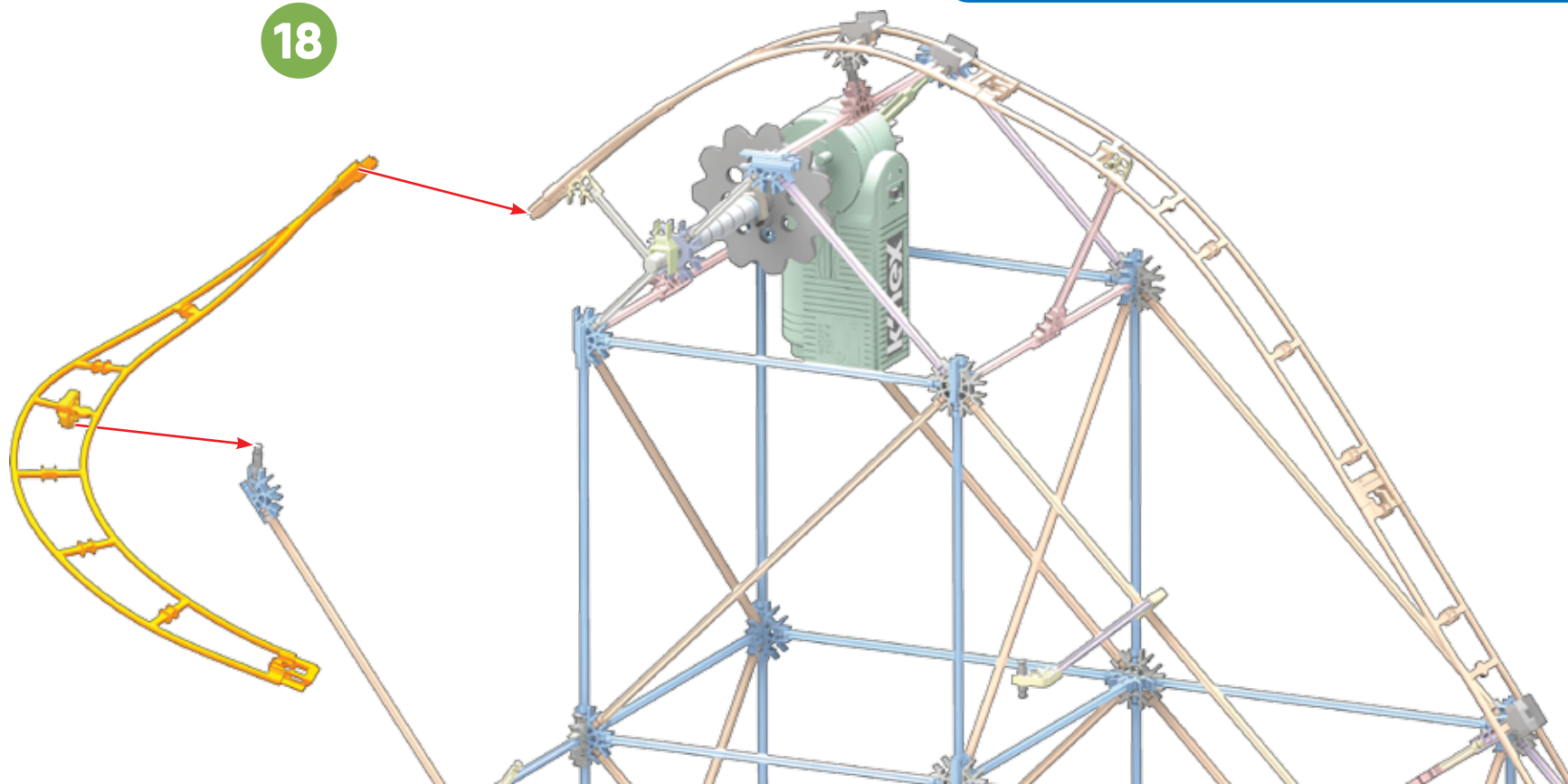

19

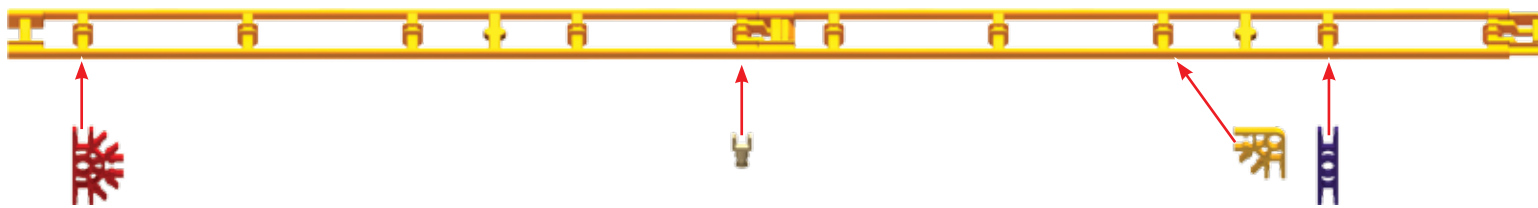

1 - 20

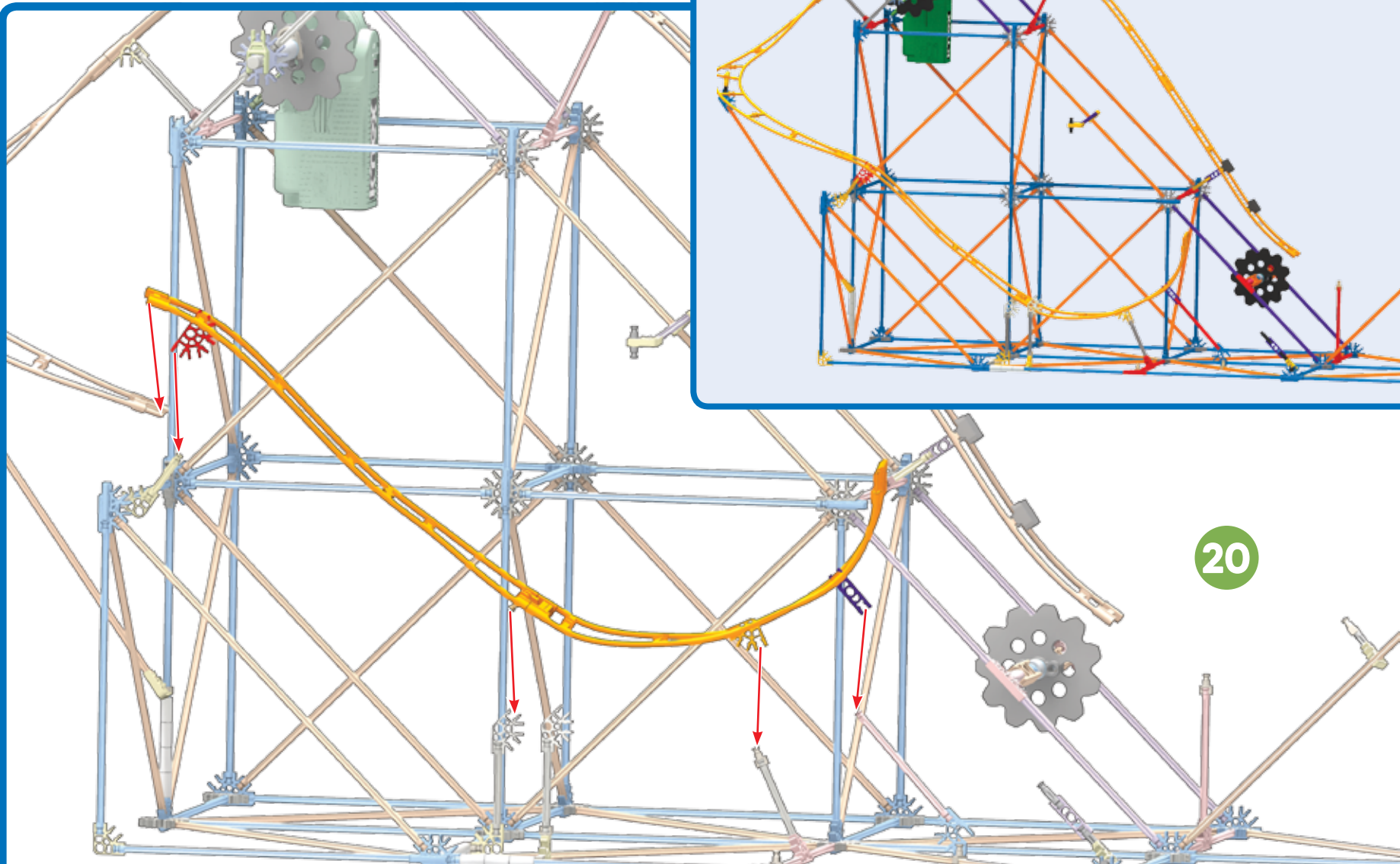
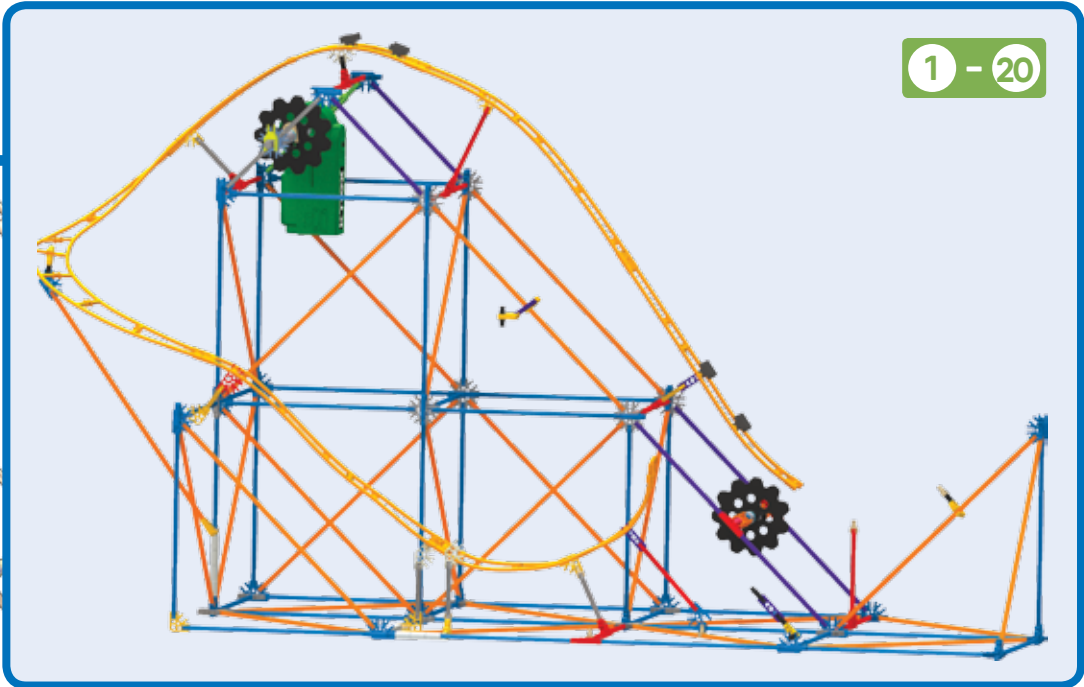

20



21



1 - 22

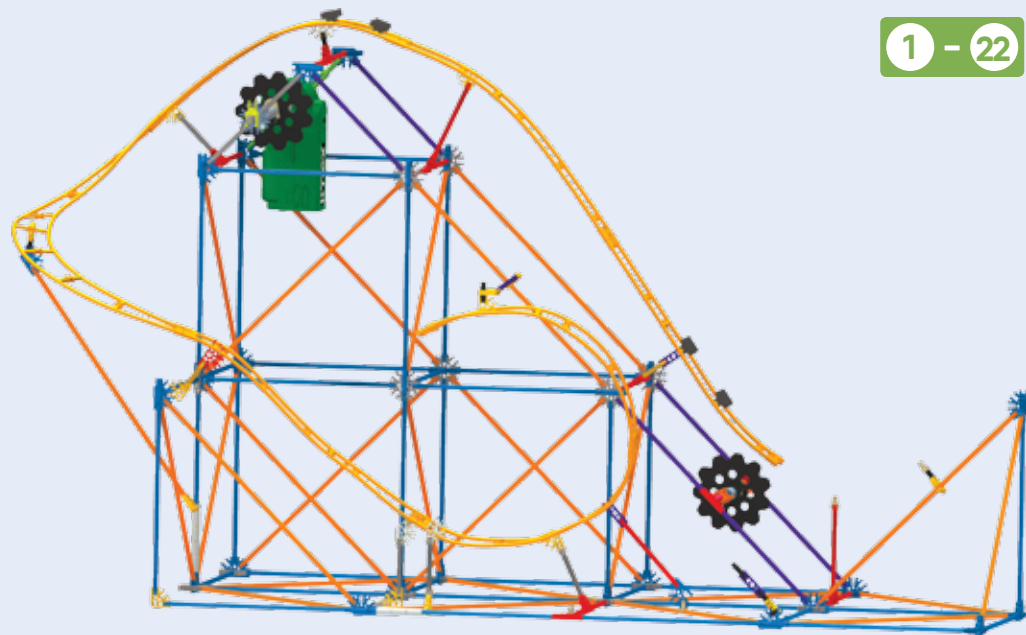

22

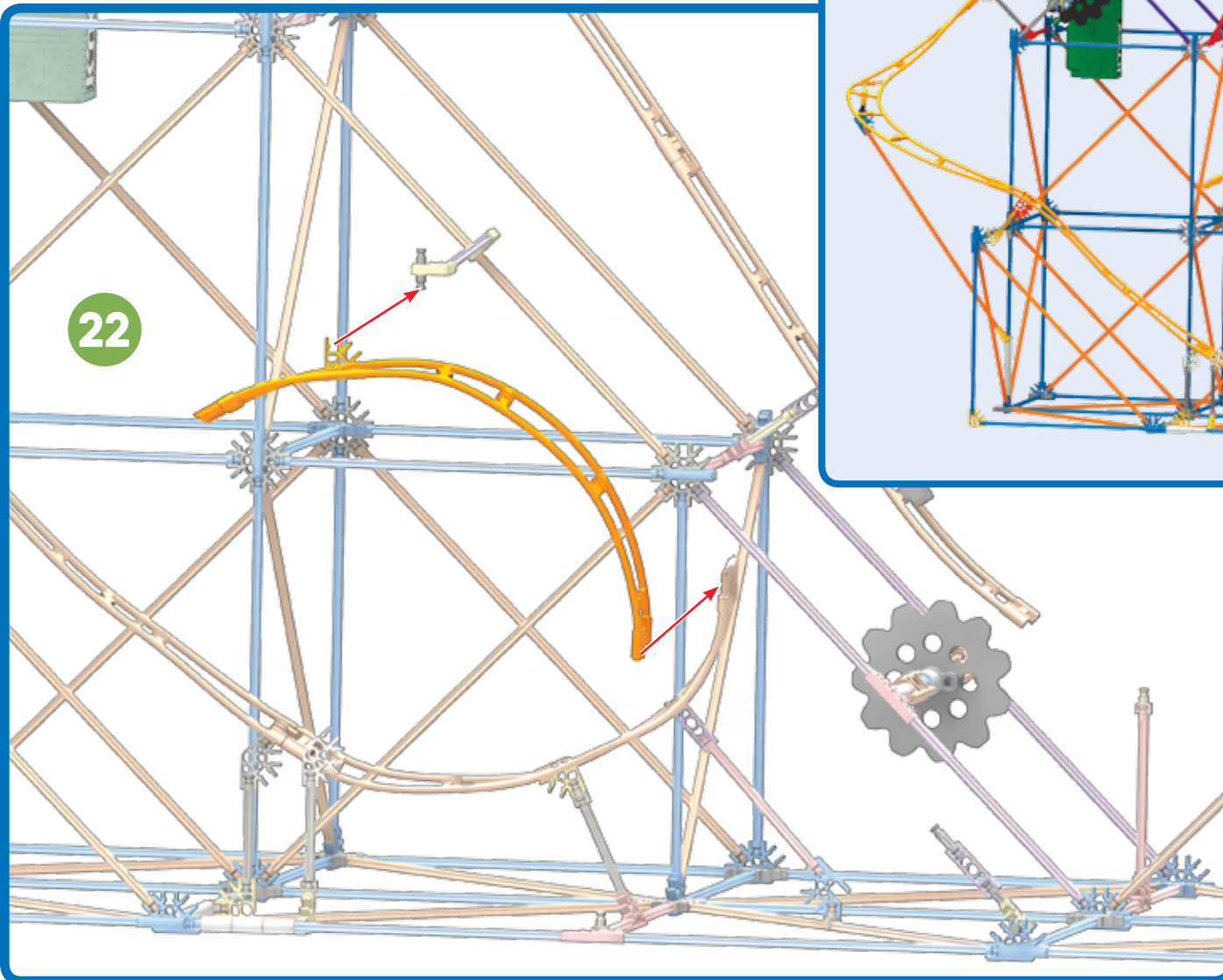

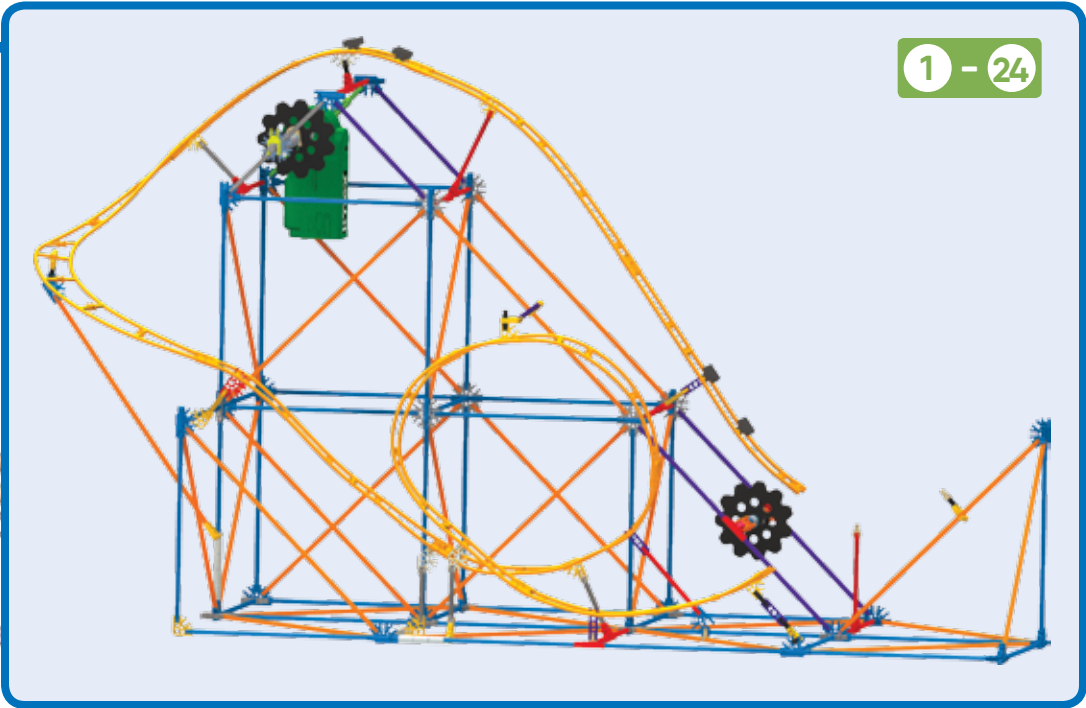
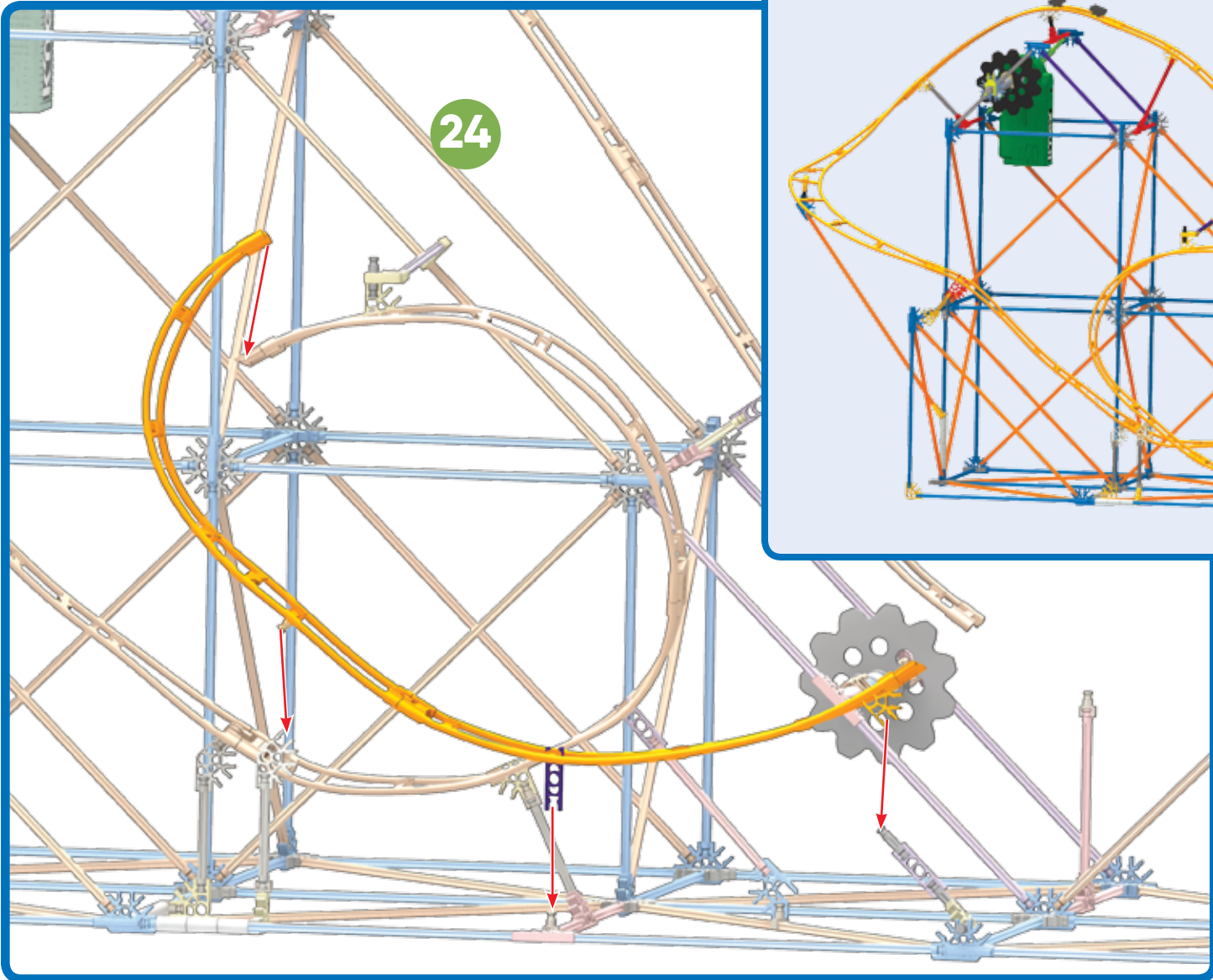
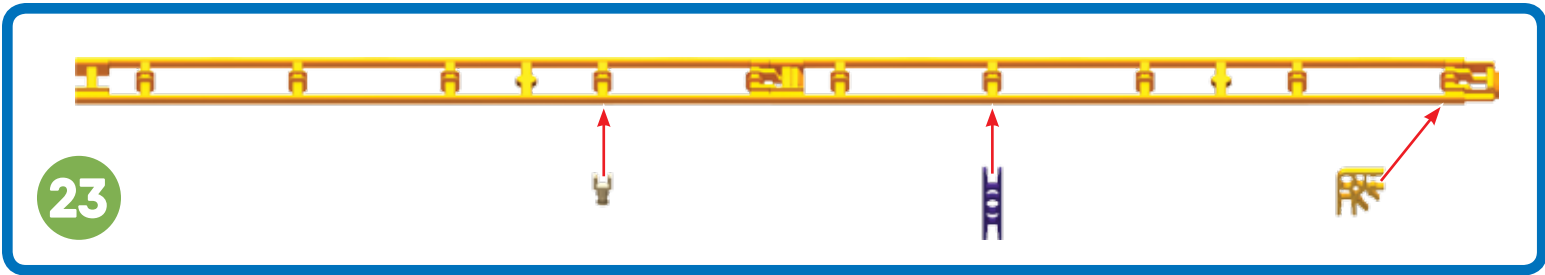

25

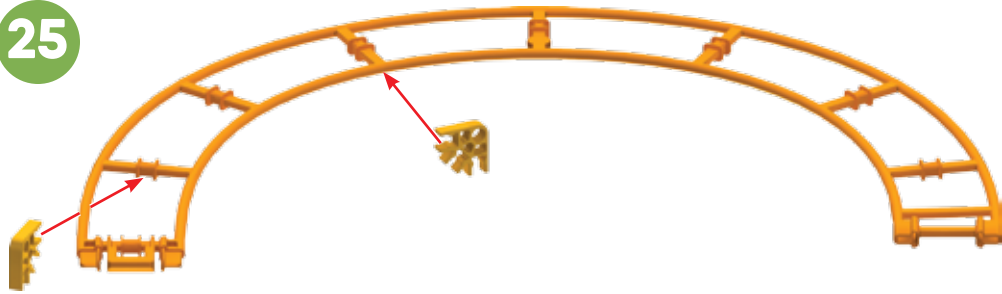

26

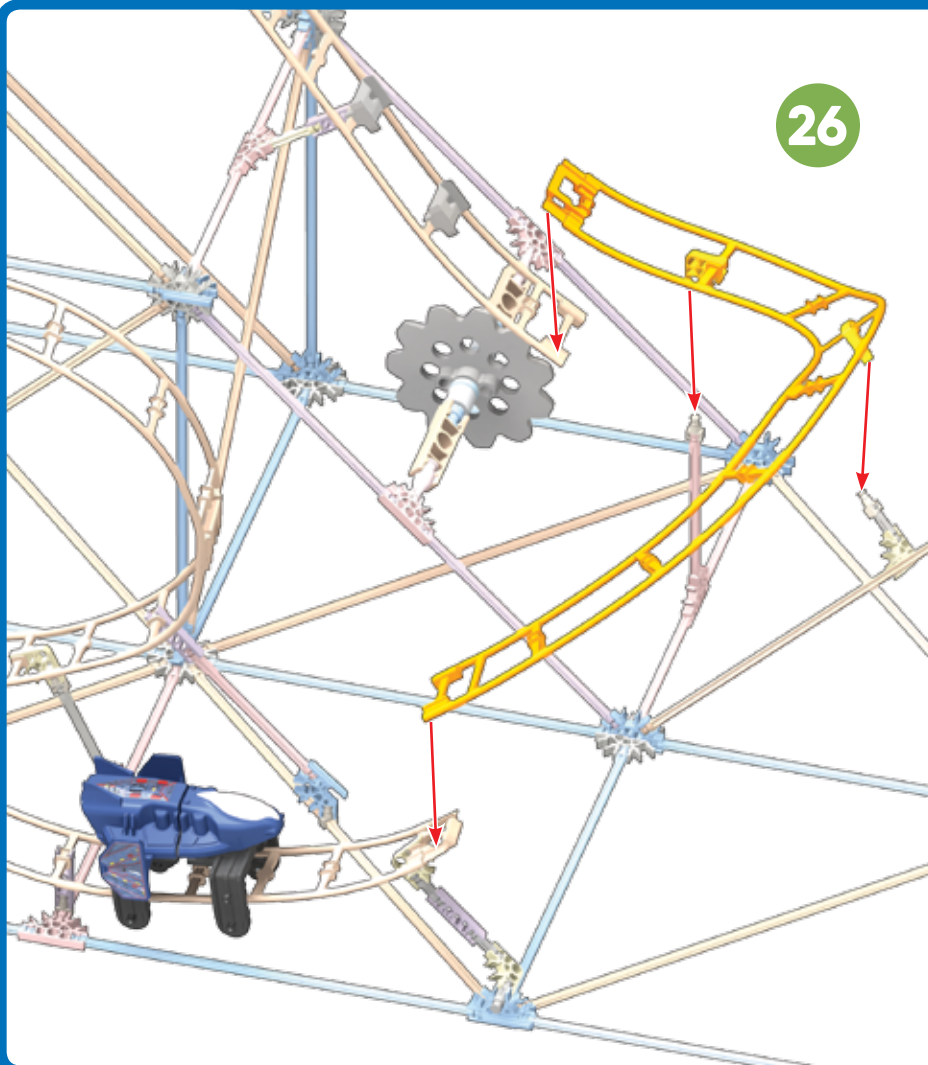

1 - 26





**IMPORTANT:** Attach all the chain links in the same direction.

**IMPORTANT :** Assure-toi de fixer tous les maillons de la chaîne dans le même sens.



27



x1

28



x7

29

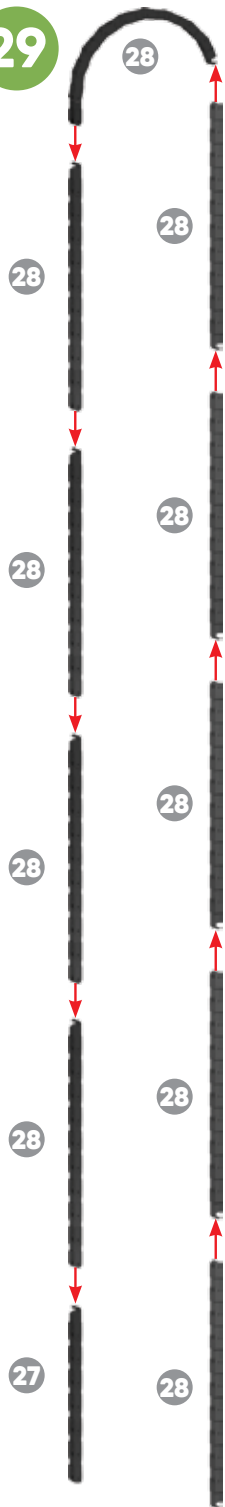

30

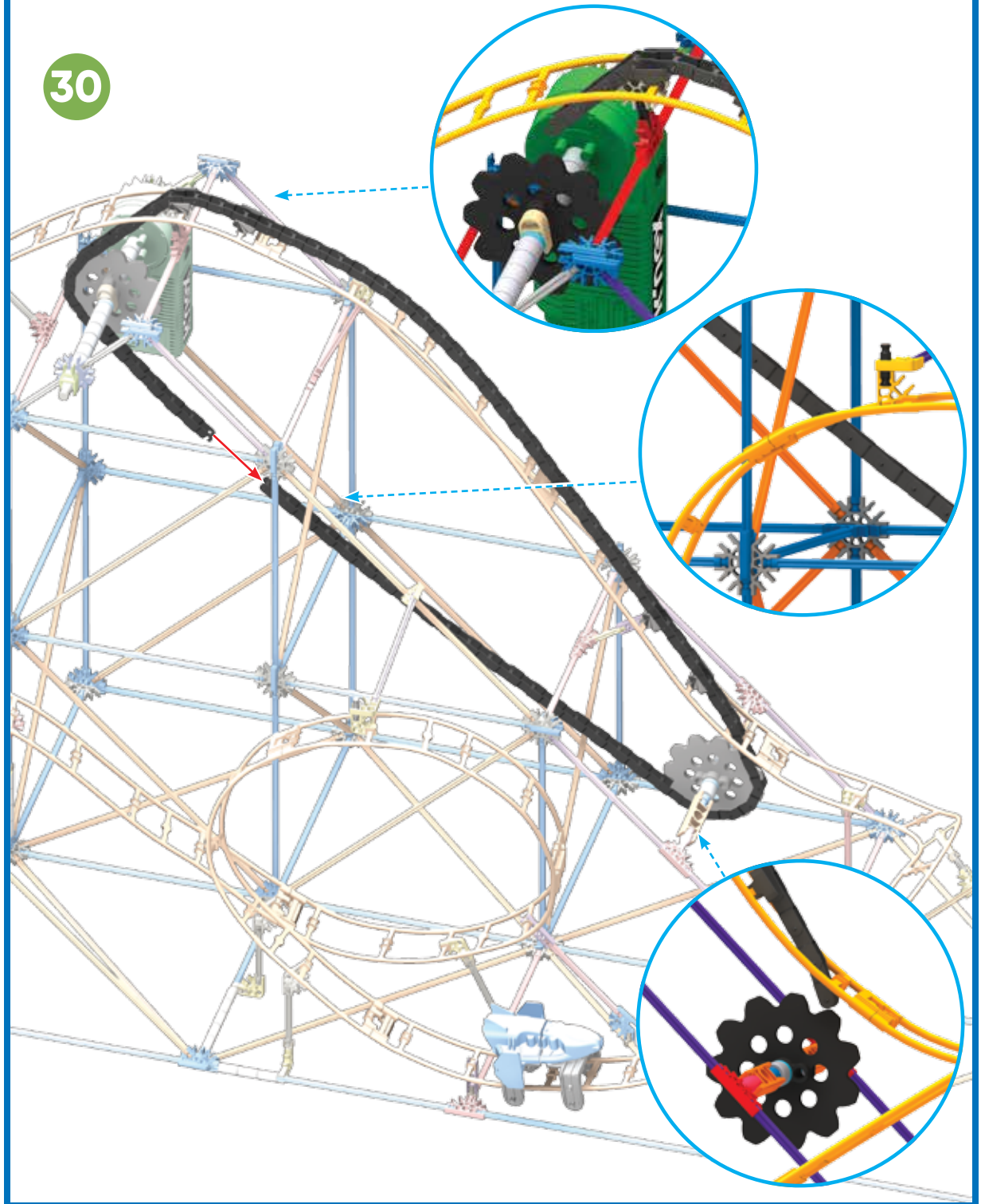

# 18515 MECHA STRIKE ALTERNATE BUILD

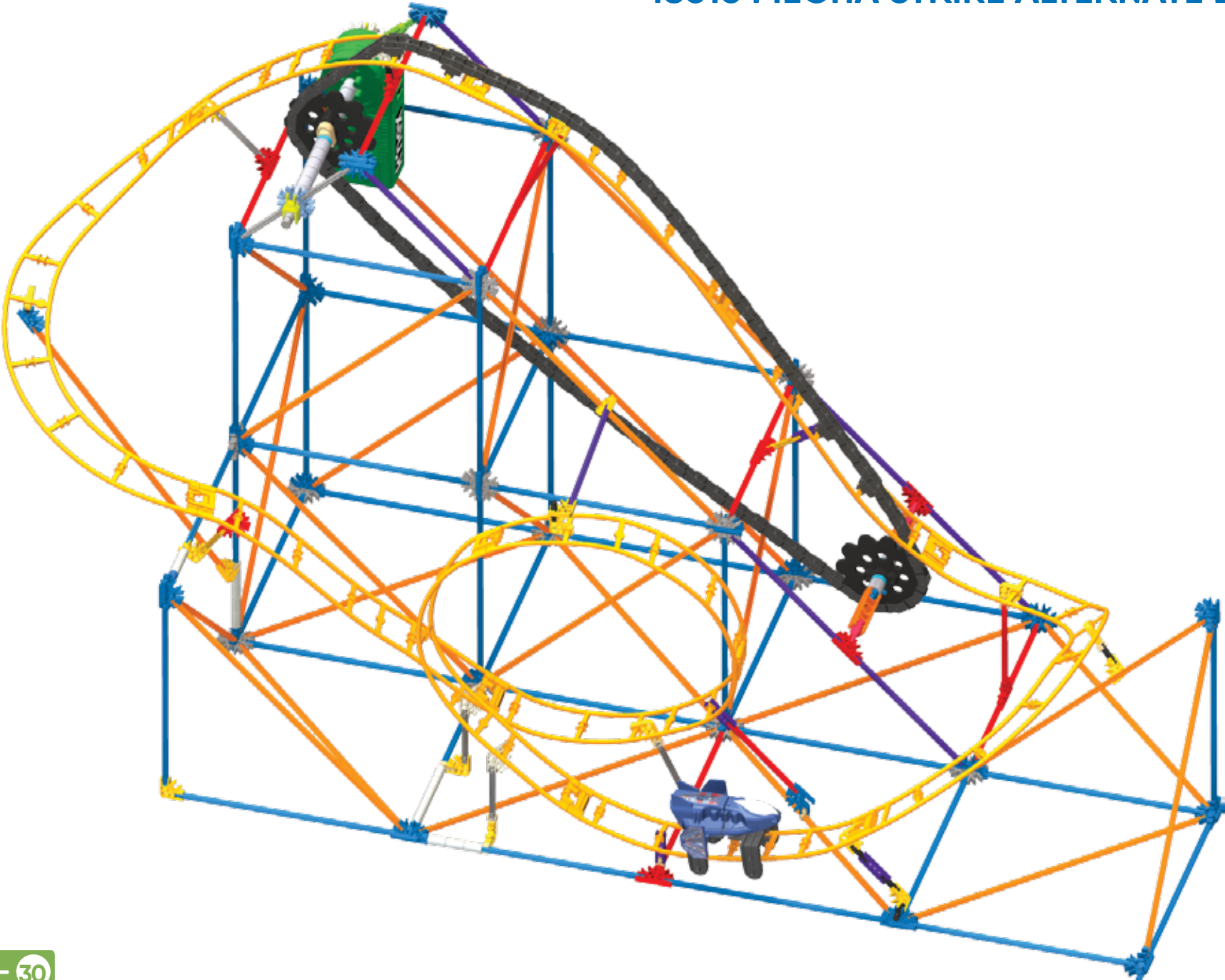

1 - 30